

Catral

GARDEN AND HOME



Catalogue Katalog

2022

Occultation | Sichtschutz | Privacy | Maskowanie

Culture | Anbau | Culture | Uprawa

Aménagement extérieur | Aussenausstattung | Outdoor fitting | Wyposażenie zewnętrzne

Décoration | Dekoration | Decoration | Dekoracje

FR DE EN PL

catralgarden.com

Sections | Sektionen | Sections | Sekcje

- 1 Occultation | Sichtschutz | Privacy | Maskowanie
- 2 Culture | Anbau | Culture | Uprawa
- 3 Aménagement extérieur | Aussenausstattung | Outdoor fitting | Wyposażenie zewnętrzne
- 4 Décoration | Dekoration | Decoration | Dekoracje



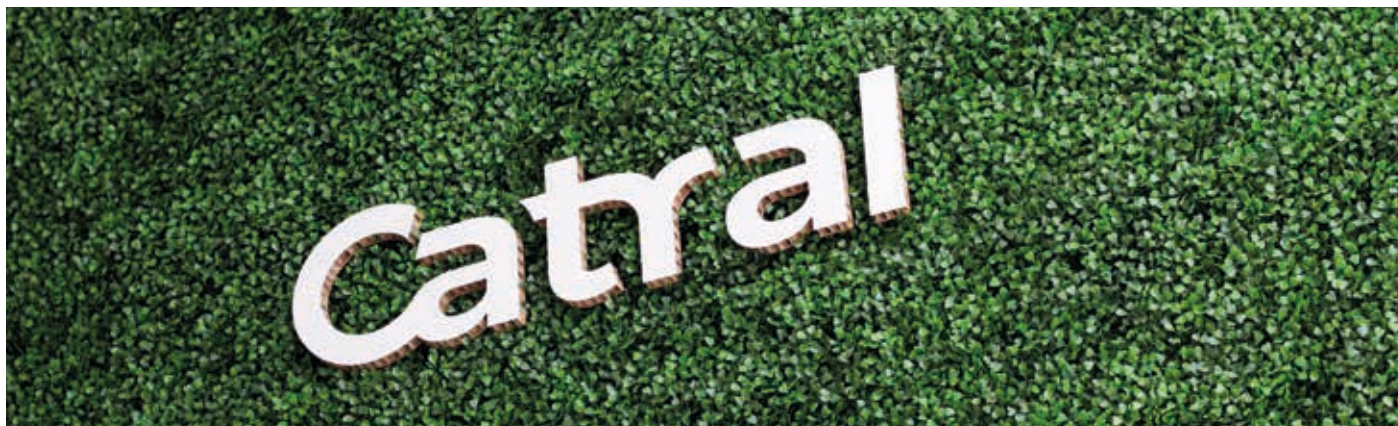

Nous sommes votre jardin, nous sommes décoration

Catral Garden a été fondée en 1928 en tant **qu'entreprise familiale** liée à l'agriculture et à la construction. Grâce à son esprit non conformiste, Catral Garden a évolué pour se transformer et devenir aujourd'hui une grande entreprise internationale et une référence nationale dans le **secteur de la culture et de la décoration**.

Notre principe de base est de **rendre la vie de nos clients plus facile et plus confortable**, en éveillant chez les gens l'envie de créer des environnements plus agréables. Pour cela nous proposons des **solutions innovantes et éco-responsables** dans le domaine du bricolage et du jardinage, avec un accent croissant mis sur la production dans nos propres installations Européenne, et sur une **chaîne d'approvisionnement responsable à haut niveau de service**.

Wir sind Ihr Garten, wir sind Dekoration

Catral Garden wurde 1928 als **Familienunternehmen** gegründet, das mit der Landwirtschaft und dem Bauwesen verbunden ist. Dank seines unkonventionellen Geistes hat sich Catral Garden weiterentwickelt und verwandelt und ist heute ein großes internationales Unternehmen und eine nationale Referenz im **Bereich Gartenbau, Anbau und Dekoration**.

Unsere Prämisse ist es, **das Leben unserer Kunden einfacher und komfortabler zu machen, indem wir** in den Menschen die Motivation wecken, ein angenehmeres Umfeld zu schaffen, und **innovative und ökologisch verantwortungsvolle Lösungen** für die Herstellung und den Vertrieb von Heimwerker- und Gartenartikeln anbieten, wobei wir uns zunehmend auf **eine verantwortungsvolle, nachhaltige und serviceorientierte Lieferkette** konzentrieren.

We are your garden, we are decoration

Catral Garden was founded in 1928 as a **family business** linked to agriculture and construction. Thanks to its non-conformist spirit, Catral Garden has been evolving and transforming itself to become a great international company and a national reference in the **gardening, cultivation and decoration sector**.

Our premise is **to make life easier and more comfortable for our customers**, prompting people to create more pleasant environments, offering **innovative and eco-responsible solutions** in manufacturing and marketing for DIY and Gardening, with an increasing focus on a **responsible, sustainable and high-service supply chain**.

Twój ogród i jego dekoracja – to my

Catral Garden została założona w 1928 roku jako **firma rodzinna**, związana z sektorem rolniczym i budowlanym. Od tego czasu, w ciągłym dążeniu do doskonałości Catral Garden rozwijała się i przekształcała. Obecnie jest wielką międzynarodową firmą, jedną z wiodących marek w hiszpańskim **sektorze ogrodnictwa, upraw i dekoracji**.

Naszym celem jest **ułatwianie życia i podnoszenie komfortu naszych klientów** poprzez motywowanie ich do tworzenia przyjemniejszego otoczenia. Oferujemy **innovacyjne i ekologicznie odpowiedzialne rozwiązania** w zakresie produkcji i marketingu dekoracji i ogrodnictwa, z rosnącym naciskiem na **odpowiedzialny, zrównoważony i wysokiej jakości łańcuch dostaw**.



Certifications | Zertifikate | Certificates | Certyfikaty

Partenaires | Partner | Partners | Członkowie



We supply
FSC® certified
products to
order



New

2022



Parasol en sparte | Sonnenschirm aus Spartogras | Esparto grass parasol



Artificial grass | Imitacja trawnika

Gazon artificiel | Kunstrasen



Plantes artificielles | Kunstpflanzen
Artificial plants | Sztuczne rośliny



Brande avec coco | Heidematte mit Kokosnusssfaser

Brise-vue | Sichtschutzgewebe



Heather with coconut | Wrzos z kokosem

Rideaux en bois | Holzvorhänge
Wood curtains | Drewniane paski na drzwi



Privacy meshes | Siatki maskujące



Indice | Index | Spis treści

Occultation | Sichtschutz | Privacy | Maskowanie

Clôtures naturelles Natürlicher Sichtschutz Natural screening..... 6 Maty naturalne	
Clôtures PVC PVC Sichtschutz PVC screening Maty PCV18	
Clôtures LOP® LOP® Sichtschutz LOP® screening Maty LOP®22	
Trellis Rankgitter Trellis Kratki25	
Trellis avec feuilles Rankgitter mit Blättern Trellis with leaves.....27 Kratki z liśćmi	
Haies artificielles Kunsthecken Artificial hedges Sztuczne żywopłoty.....30	
Brise Vue Sichtschutzgewebe Privacy meshes Siatki maskujące.....36	
Moustiquaires et grillages Sicherheitsnetze.....45 Protective meshes Siatki ochronne	

Culture | Anbau | Culture | Uprawa

Potagers urbains Urban Gardens Urban gardens.....52 Miejskie ogrody warzywne	
Paillage Anti-Unkraut Netze Anti-herb meshes.....58 Siatki na chwasty i do odgradzania upraw	
Protection des plantes Pflanzenschutz.....59 Crop protection Ochrona upraw	
Récolte Sammlung Organic waste collection Zbieranie plonów60	
Croissance Wachstum Growth Wzrost roślin.....60	

Aménagement extérieur | Aussenausstattung Outdoor Fitting | Wyposażenie Zewnętrzne

Gazon artificiel Kunstrasen Artificial grass Imitacja trawnika.....62	
Bois extérieur Holz für den Außenbereich Outdoor wood.....72 Drewno zewnętrzne	
Bordures et clôtures Beetabgrenzungen und Zäune83 Borders and fences Palisady i ogrodzenia	
Sols Bodenbeläge Floors Podłogi.....91	
Abris de jardin et bâches Gartenhäuser und Planen.....92 Garden sheds and tarpaulins Domki narzędziowe i markizy	

Décoration | Dekoration | Decoration | Dekoracje

Plantes artificielles Kunstpflanzen Artificial plants Sztuczne rośliny.....100	
Jardins verticaux Vertikale Gärten Vertical gardens Ogrody wertykalne.....106	
Boules décoratives Dekorative Kugeln Decorative orbs Kule ozdobne.....111	
Tuteurs décoratifs Dekorative Stangen Decorative stakes.....112 Kije dekoracyjne	
Stores Jalousies Blinds Rolety.....113	
Rideaux en bois Holzvorhänge Wood curtains.....114 Drewniane paski na drzwi	
Fruits et légumes Künstliche Früchte und Gemüse.....115 Fruits & Vegetables Owoce i warzywa	

Solutions au point de vente | Lösungen für die Verkaufsstelle Point-of-sale solutions | Rozwiązania w miejscu sprzedaży

Présentoirs et pédagogies Aussteller und Pädagogen.....119 Exhibitors and pedagogies Stoiska wystawowe i materiały dydaktyczne	
---	--

Realité augmentée Augmented Reality



Pointez votre téléphone portable sur le **code QR** que vous voyez sur la page ou l'écran
Zeigen Sie mit Ihrem Handy auf den **QR-Code**, den Sie auf der Seite oder dem Bildschirm sehen
Focus with your smartphone to the **QR code** you see on the page or screen
Skieruj aparat telefonu na **kod QR** widoczny na stronie lub na ekranie



Occultation | Sichtschutz
Privacy | Maskowanie





Clôtures naturelles

Grâce au processus de sélection et de récolte de matières premières réalisées par Catral Garden, nous garantissons une finition homogène pour réaliser une occultation très esthétique pour votre jardin. Les produits naturels sont uniques et peuvent présenter quelques variations dans leur apparence.

Dessin exclusif

Esthétique et discrète, c'est une excellente solution pour protéger votre extérieur des regards. Son aspect naturel permet de créer une ambiance accueillante pour le jardin, balcon ou terrasse.

Natürlicher Sichtschutz

Dank des von Catral entwickelten Selektionsverfahrens, sorgen wir für eine gleichmäßige Verarbeitung der Stäbe mit gleichem Durchmesser und bieten so den perfekten Sichtschutz für jeden Garten. Naturprodukte sind einzigartig und können sich in ihrem Aussehen unterscheiden.

Exklusives Design

Ästhetisch, natürlich und diskret, ein natürlicher Sichtschutz. Durch seine Zusammensetzung ermöglicht es eine gemütliche Atmosphäre für den Garten, Balkon oder Terrasse zu schaffen.

Natural screening

Thanks to the selection process and the cutting of the raw material, we guarantee a homogeneous finish providing a perfect screening for gardens. Natural products are unique and these can show some variations in their appearance.

Exclusive Design

Esthetical, natural and discreet, it's an outstanding natural screening. Its composition allows you to create a cosy environment for your garden, balcony or terrace.

Maty naturalne

Zaawansowany proces selekcji i cięcia surowca zapewnia idealne maty ogrodowe z prętami o tej samej grubości i jednolitym wykończeniu. Naturalne produkty są unikalne i mogą pokazać pewne różnice w ich wyglądzie.

Wyjątkowy design

Maty naturalne stanowią doskonałe ogrodzenie, umożliwiając stworzenie przytulnej atmosfery w ogrodzie, na balkonie lub na tarasie. Wykonane z organicznych materiałów o estetycznym wyglądzie zapewnią pełną dyskrecję.

Osier
Weide
Willow
Wiklina 8

Canisse
Schilfrohr
Reed Screen
Ostony z trzciny 11

Paillon
Bambus
Bamboo
Bambus 12

Brande
Heide
Heather screen
Ostona z wrzosu 13

Clôture fougère
Farnmatte Gewoben
Woven Fern Screen
Mata z paproci 16

Ecorce de pin tissée
Kiefernringenmatte
gewoben
Woven pine Bark
Mata z kory sosnowej 16

Accessoires
Zubehör
Accessories
Akcesoria 17





Osier Multi | Weide Multi
Multi Willow | Wiklina MULTI



- FR** Assemblage de fines branches d'osier naturel, tissées avec un fil de fer galvanisé. Haut niveau d'occultation.
- DE** Kombination von natürlichen und ökologischen Weidenruten mit unterschiedlicher Dicke. Mit verzinktem Draht verwebt. Hohes Maß an Privatsphäre.
- EN** Combination of natural and ecological Willow Rods with different thickness. Woven with galvanised wire. High level of privacy.
- PL** Naturalne i ekologiczne pręty wiklinowe o różnej grubości przeplatane drutem ocynkowanym o wysokim poziomie maskowania.



🏠	📏	m	📦	🚚
15060001	8 422502 36704 7	1x3	1	36
15060002	8 422502 10606 6	1,5x3	1	36
15060003	8 422502 20478 6	2x3	1	32



Osier fendu | Weide gespalten
Split Willow | Wiklina
jednostronna BICOLOR



- FR** Combinaison de tiges en osier naturel fendu. En alternant la position de la tige, il est possible d'obtenir une finition bicolore unique, différente du reste des clôtures naturelles.
- DE** Kombination aus gespaltenen natürlichen Weidenruten. Die Position der Rute wechselt, wodurch eine einzigartige zweifarbige Oberfläche entsteht, die sich von den übrigen natürlichen Sichtschutten unterscheidet.
- EN** Combination of natural split wicker rods. The position of the rod alternates, achieving a unique two-colour finish different from all other natural enclosures.
- PL** Ogródzenie z kawałków naturalnych prętów wiklinowych. Ich specjalne ustawienie daje efekt oryginalnego, dwukolorowego wykończenia, które odróżnia je od innych ogrodzeń tego typu.



🏠	📏	m	📦	🚚
15050004	8 422502 68422 9	1x3	1	48
15050005	8 422502 79918 3	1,5x3	1	48
15050006	8 422502 84016 8	2x3	1	48



**Osier STANDARD | STANDARD Weiden
STANDARD Willow | Wiklina STANDARD**



- FR** Tiges en osier naturel non pelé, tissées avec du fil de fer galvanisé. Bon niveau d'occultation.
- DE** Natürliche ungeschälte Weidenruten mit verzinktem Draht verwoben. Hoher Sichtschutz.
- EN** Natural unpeeled willow with galvanised wire. Excellent privacy level.
- PL** Mata z prętów naturalnej, nieobranej wikliny przeplatana drutem ocynkowanym.



🏠		m	📦	🚚
15010001	8 422502 24008 1	1x3	1	50
15010002	8 422502 24010 4	1,5x3	1	30
15010004	8 422502 24012 8	2x3	1	30
15010006	8 422502 24001 2	1x5	1	25
15010007	8 422502 24002 9	1,5x5	1	25
15010008	8 422502 24003 6	2x5	1	20



**Osier STANDARD COASTLINE
STANDARD COASTLINE Weiden
STANDARD COASTLINE Willow
Wiklina STANDARD COASTLINE**



- FR** Tiges en osier naturel non pelé, tissées avec du fil de fer galvanisé.
- DE** Natürliche ungeschälte Weidenruten mit verzinktem Draht verwoben.
- EN** Natural unpeeled willow with galvanised wire.
- PL** Mata z prętów naturalnej, nieobranej wikliny przeplatana drutem ocynkowanym.



🏠		m	📦	🚚	
15090001	8 422502 95438 4	1x3	3	50	NEW!
15090002	8 422502 22294 0	1,5x3	2	30	NEW!
15090003	8 422502 24326 6	2x3	1	30	NEW!



Osier ECO | ECO Weiden
ECO Willow | Wiklina ECO



- FR** Osier naturel non pelé, tissé avec du fil galvanisé en double torsion.
- DE** Natürliche ungeschälte Weidenruten mit verzinktem Draht in Doppelknoten verwoben.
- EN** Natural unpeeled willow with galvanised double knot wire.
- PL** Naturalna mata z nieobranej wikliny, przeplatana drutem ocynkowanym, podwójnie wiązany.



🏠	📏	m	📦	🚚
15020004	8 422502 94979 3	1x3	1	36
15020005	8 422502 20475 5	1,8x3	1	36



Osier PREMIUM | Weidenmatte
PREMIUM | PREMIUM Willow
Wiklina PREMIUM



- FR** Sélection de la dernière campagne d'osier national, couleur rougeâtre. Tissée par des travailleurs spécialisés et sous des contrôles stricts de qualité pour obtenir une finition parfaite et un haut niveau d'occultation.
- DE** Ausgewähltes Material von einheimischen Weidenruten der letzten Ernte mit rötlichem Farbton In Catral (Alicante-Spanien) von spezialisierten Facharbeitern nach strengsten Qualitätsmaßstäben geflochten um ein perfektes Finish und ein hohes Maß an Privatsphäre zu erreichen.
- EN** Selection of national willow from the latest season with reddish color. Woven in Catral (Alicante-Spain) by specialised workers and subject to strict quality control to obtain a perfect finish and high privacy level.
- PL** Wybór ostatniej krajowej kampanii wiklinowej. Mata z wikliny w czerwonym odcieniu, wyplatana przez specjalnie przeszkolonych pracowników z zachowaniem ścisłych zasad kontroli jakości. Idealne wykończenie i wysoki poziom maskowania.

🏠	📏	m	📦	🚚
15030001	8 422502 24020 3	1x3	1	36
15030003	8 422502 24022 7	1,5x3	1	36
15030005	8 422502 24028 9	2x3	1	36



Canisse | Schilfrohr | Reed Screen Ostony z trzciny



- FR** Roseau naturel espagnol tissé avec du fil de fer galvanisé.
- DE** Natürliches spanisches Schilfrohr mit verzinktem Draht verwoben.
- EN** Natural Spanish cane with galvanised wire.
- PL** Naturalne gałązki z trzciny przeplatane drutem ocynkowanym.



Canisse roseau fendu | Gespaltener Bergbambus Half reed screen | Niepełne gałązki trzciny

📦	📏	m	📄	📦
12010001	8 422502 01001 1	1x5	1	36
12010002	8 422502 01003 5	1,5x5	1	36
12010003	8 422502 01005 9	2x5	1	36

Canisse entière | Spanischer Bergbambus Reed screen | Pełne gałązki trzciny

📦	📏	m	📄	📦
12020001	8 422502 02001 0	1x5	1	20
12020002	8 422502 02002 7	1,5x5	1	20
12020003	8 422502 02003 4	2x5	1	20



Canisse roseau entière Medium Bambus aus ganzem Rohr Whole Cane Medium Rod Pełne gałązki trzciny ŚREDNIE PRĘTY



- FR** Tiges de roseau naturel et écologique de diamètre medium très homogène, tissées avec du fil de fer galvanisé tous les 10cm.
- DE** Natürliche, ökologische Weide, bestehend aus gleichförmigen Stäben mittlerer Dicke, alle 10 cm mit verzinktem Draht verwoben.
- EN** Natural and ecological canes, composed of medium thickness uniform rods, woven with galvanised wire every 10 cm.
- PL** Naturalne i ekologiczne jednolite pręty trzciny o średniej grubości przeplatane drutem ocynkowanym na całej długości, a w odstępach 10 cm ocynkowanym drutem stalowym.



📦	📏	m	📄	📦
12060001	8 422502 56746 1	1x5	1	30
12060002	8 422502 94274 9	1,5x5	1	30
12060003	8 422502 08129 5	2x5	1	30



Bambou entier tissé
Bambus aus ganzem Rohr
Woven bamboo
Mata z całych prętów bambusa



- FR** Tiges de bambou tissées avec du fil galvanisé.
- DE** Natürliche Bambusstangen mit verzinktem Draht genäht.
- EN** Natural bamboo rods sewn with galvanized wire.
- PL** Naturalne gałązki bambusowe przeplatane drutem ocynkowanym.



📦	📏	m	📄	📦	
12030004	8 422502 55621 2	1x3	1	36	NEW!
12030005	8 422502 02956 3	1,8x3	1	36	NEW!
12030001	8 422502 71001 0	1x5	1	25	
12030002	8 422502 71004 1	1,5x5	1	25	
12030003	8 422502 71007 2	2x5	1	25	



Paillon pelé tissé
Schilfrohrmatte geschält
Woven peeled bamboo
Mata z obranego bambusa



- FR** Roseau naturel pelé tissé avec du fil de fer plastifié.
- DE** Natürliches Bambusrohr mit Verzinkten Draht gewoben.
- EN** Natural bamboo with plasticised wire.
- PL** Naturalne pręty bambusowe przeplatane plastyfikowanym drutem.



📦	📏	m	📄	📦	
12040001	8 422502 03001 9	1x5	5	50	
12040002	8 422502 03004 0	1,5x5	5	50	
12040003	8 422502 03007 1	2x5	5	40	



Brande COMBI
COMBI Heide
COMBI heather screen
Ostona z wrzosu COMBI



- FR** Combinaison de tiges de bruyère et d'osier naturel, tissées avec un fil galvanisé pour assurer un haut niveau d'occultation.
- DE** Kombination von Heidematte und Weideruten, verwebt mit verzinktem Draht. Bietet extrem hohen Sichtschutz.
- EN** Combination of Heather matt and willow rod. Woven with zinc wire. Offers extrem high privacy.
- PL** Połączenie naturalnych prętów wrzosowych i wiklinowych przeplatanych drutem ocynkowanym o wysokim poziomie maskowania.



2.200-
2.600
g/m²

📦	📏	m	📦	📦
11070001	8 422502 83542 3	1x3	1	24
11070002	8 422502 13272 0	1,5x3	1	24
11070003	8 422502 77841 6	2x3	1	24



Brande de bruyère avec coco
Heidematte mit Kokosnussfaser
Heather with coconut | Wrzos z kokosem



- FR** Cette nouvelle clôture combine trois couches qui assurent une robustesse et une occultation maximale. En insérant une couche de tissu de fibres de coco entre deux couches de bruyère, la clôture combine l'aspect naturel de la bruyère avec une excellente occultation.
- DE** Dieser neue Sichtschutz kombiniert drei Schichten, die für Robustheit und maximale Deckung sorgen. Durch den Wechsel von zwei Schichten aus Heidekraut und einer aus Kokosnuss entsteht ein natürliches Aussehen und ein hoher Grad an Deckkraft.
- EN** This new screening combines three folds that provide robustness and maximum privacy. By alternating two folds of heather and one of coconut, it gives a natural look with effective masking.
- PL** Nowe ogrodzenie stanowiące połączenie trzech paneli, skutecznie izolujących wewnętrzną przestrzeń. Dwa panele wrzosowe i jeden z włókna kokosowego, ułożone naprzemiennie, zapewniają naturalny wygląd i pełną intymność.



+/-
2.500
g/m²

📦	📏	m	📦	📦	
11130001	8 422502 60180 6	1x3	1	30	NEW!
11130002	8 422502 37490 8	1,5x3	1	30	NEW!
11130003	8 422502 76553 9	2x3	1	30	NEW!



OCCULTATION | SICHTSCHUTZ | PRIVACY | MASKOWANIE



Clôture brande écologique
Ökologische Heidematte
Ecological heather screen
Ostona z ekologicznego wrzосу

- FR** Le tissu est obtenu à partir de branches naturelles de bruyère tissées avec du fil d'acier galvanisé tous les 10 cm.
- DE** Das Gewebe wird aus mit Faden gewebten Zweigen aus natürlichem Heidekraut hergestellt Stahl verzinkt alle 10 cm.
- EN** The fabric is obtained with natural heather branches woven with galvanized steel thread every 10 cm.
- PL** Ostona wyprodukowana z naturalnych gałązek wrzосу, przepłatanych stalowym drutem ocynkowanym co 10 cm.



				Standard	
📦	📏	m	📄	🚚	
11010001	8 422502 04100 8	1x5	1	50	
11010002	8 422502 04150 3	1,5x5	1	50	
11010003	8 422502 04200 5	2x5	1	44	



				Medium	
📦	📏	m	📄	🚚	
11020001	8 422502 04001 8	1x5	1	24	
11020002	8 422502 04004 9	1,5x5	1	24	
11020003	8 422502 04007 0	2x5	1	24	



				Medium Plus	
📦	📏	m	📄	🚚	
11030001	8 422502 04023 0	1x5	1	24	
11030002	8 422502 04024 7	1,5x5	1	24	
11030003	8 422502 04025 4	2x5	1	24	



				Superior	
📦	📏	m	📄	🚚	
11040001	8 422502 59080 3	0,8x3	1	21	
11040002	8 422502 59103 9	1x3	1	21	
11040003	8 422502 59123 7	1,2x3	1	21	
11040004	8 422502 59153 4	1,5x3	1	21	
11040005	8 422502 59203 6	2x3	1	21	



Brande rustique tissée | Rustikale Heidematte | Rustic heather screen Ostona z rustykalnego wrzosu



- FR** Bruyère très épaisse, avec pouvoir d'occultation très élevé.
- DE** Die dichtesten Heidekrautmatten am Markt mit unübertroffenen Sichtschutz.
- EN** This is the market's thickest heather brushwood, and the most effective at providing privacy.
- PL** Mata z bardzo grubych gałązek wrzosu, która zapewnia wysoki poziom maskowania i prywatności.



+/-
4.500 g
/m²

📦	🏠	m	📄	📦
11050009	8 422502 47973 3	1x3	1	16
11050011	8 422502 84375 6	1,5x3	1	16
11050012	8 422502 40571 8	2x3	1	16



Clôture fougère | Farnmatte Gewoben
Woven Fern Screen | Mata z paproci



- FR** Tiges de fougère sélectionnées, tissées avec du fil de fer galvanisé.
- DE** Ausgesuchte Farnzweige mit verzinktem Draht verwoben.
- EN** Selected fern sticks with galvanised wire.
- PL** Wyselekcjonowane gałązki paproci przeplatane drutem ocynkowanym.



📦	📏	m	📄	📦
13010001	8 422502 10105 4	1x5	1	35
13010002	8 422502 10150 4	1,5x5	1	35
13010003	8 422502 10205 1	2x5	1	35



Ecorce de pin tissée
Kiefernringenmatte gewoben
Woven pine Bark
Mata z kory sosnowej



- FR** Lames d'écorce de pin naturel, tissées avec du fil de fer plastifié.
- DE** Kiefernringenmatte mit kunststoffummanteltem Draht verwoben.
- EN** Pine Bark woven with plastic-coated wire.
- PL** Płytki naturalnej kory sosnowej przeplatane plastyfikowanym drutem.



📦	📏	m	📄	📦
16010001	8 422502 26005 8	1x5	1	20
16010002	8 422502 26006 5	1,5x5	1	20
16010003	8 422502 26007 2	2x5	1	20



Accessoires d'installation | Zubehör für die Montage | Installation accessories Akcesoria montażowe

- FR** Ces accessoires sont nécessaires pour réaliser une installation solide et élégante des clôtures naturelles
- DE** Wir präsentieren Ihnen das notwendige Zubehör für die Installation von natürlichen Sichtschutz.
- EN** We present the necessary accessories for the installation of natural enclosures.
- PL** Przedstawiamy niezbędne akcesoria do montażu obudów naturalnych.

**Twister Hook + 100 liens métalliques
Twister Hook + 100 Bindedrähte
Twister Hook + 100 metal flanges
Twister Hook + 100 kołnierze metalowe**

- FR** Le *Twister Hook* est un outil semi-automatique qui facilite l'installation de canisses ou de nattes sur une clôture, un grillage ou fils de tension, grâce à la torsions simple et rapide des liens métalliques prévus à cet effet.
- DE** Der *Twister Hook* ist ein halbautomatisches Werkzeug, das bestimmt ist um die Installation von Schilf, Maschen, Spalieren ... zu erleichtern, bei a Zaun-, Pfosten- oder Sockelzaun, durch Verbinden von Metallflanschen durch einfaches, schnelles und müheloses Verdrehen.
- EN** The *Twister Hook* is a semi-automatic tool designed to facilitate the installation of reeds, meshes, trellises, etc., to a fence, post or base fence, by twisting metal flanges together in a simple, quick and effortless way.
- PL** *Twister Hook* jest półautomatycznym narzędziem przeznaczonym do ułatwienia montażu stroików, siatek, treliazy itp. do ogrodzenia, słupka lub cokołu ogrodzenia, poprzez łączenie metalowych kołnierzy za pomocą skręcania w prosty, szybki i bezwysiłkowy sposób.



		cm		
48010009	8 422502 93527 7	27x16,5x5	10	480



**Pack 50 Liens verts | 50er Pack Bindedrähte
Pack 50 Green flanges | Zestaw opasek kablowych z plastiku 50 szt.**



		cm		
48010010	8 422502 26344 8	27,5x10x1	25	2400

Canisses PVC

Large gamme de qualité avec finitions et couleurs tendance, conçue et produite au siège de Catral à Alicante.

N° 1 sur le marché

Catral possède la plus grande usine de production de canisses en plastique d'Europe de production de canisses plastiques, et propose la gamme de canisses PVC la plus large et fonctionnelle du marché.

Garantie de qualité CATRAL

Catral produit cette gamme dans son usine, et en maîtrise tout le process industriel avec le plus haut niveau d'exigence.

PVC-Siebung

Breite Palette an Materialien und Farben, entworfen in unserem Hauptsitz in Catral, Alicante.

Die NR.1 Auf dem Markt

Catral Gardens besitzt die größte PVC-Siebanlage und entwickelt und produziert das breiteste und funktionellste PVC-Sortiment.

CATRAL Qualitätsgarantie

Catral fertigt dieses Sortiment mit eigenen Anlagen und integriert den gesamten Produktionsprozess mit höchsten Qualitätsanforderungen.

PVC Screening

Wide range of materials, finishing and colour trends, designed in our headquarters in Catral, Alicante.

No. 1 in the market

Catral Gardens owns the largest plant of PVC Screening and develops the widest and functional range of PVC.

CATRAL Quality warranty

Catral manufactures this range in its own facilities and also integrates the whole production process with the highest quality requirements.

Ogrodzenia z PCV

Szeroka gama produktów i dodatków w modnych kolorach opracowana w siedzibie Catral w Alicante.

Nr 1 na rynku

Catral Garden jest właścicielem największej europejskiej fabryki oston z tworzyw sztucznych, oferującej najpełniejszą i najbardziej funkcjonalną linię produktów z PCV na rynku.

Gwarancja jakości CATRAL

Catral produkuje tę linię we własnych zakładach, integrując cały proces produkcji z zachowaniem najwyższych standardów jakości.

Canisse PVC E-plus
E-Plus PVC
Sichtschutzmatten
E-PLUS PVC Screen
Ostona PCV E-plus

19

Canisse Superior 20 mm
20 mm PVC
Sichtschutzmatten
20 mm PVC Superior
Screen
Ostona Superior
PCV 20 mm

20

Kit fixation
Befestigungskit
Fixing Kit
Zestaw mocujący z PVC

21

Profilés de finition PVC
U-Profile PVC-
Sichtschutzmatten
U Profiles PVC Screens
Profile płotkowe w
kształcie litery „U” z PCV

21





Canisse PVC E-plus
E-Plus PVC Sichtschutzmatten
E-PLUS PVC Screen | Ostona PCV E-plus



- FR** Profils en plastique de haute qualité, de 20 mm de large, cousus avec du fil de nylon collé sur toutes les tiges et les points. Avec traitement anti-UV.
- DE** 20 mm breite, hochwertige PVC-Stangen, genäht mit Nylonfaden, der an allen Stäben und Stichen verklebt ist. Mit Anti-UV-Behandlung.
- EN** 20 mm wide, high-quality plastic profiles, sewn with nylon thread glued to all rods and stitches. With anti-UV treatment.
- PL** Listewki o szerokości 20 mm, wykonane z wysokiej jakości tworzywa sztucznego, połączone nylonową nicią, mocowaną do listew i szwów przy pomocy specjalnego kleju. Odporne na promieniowanie UV.



E-PLUS Simple face | E-PLUS Einseitig
E-PLUS Simple face | E-PLUS Jedna strona

Color	Code	Dimensions	m	Rolls	Rolls	NEW!
White	41090018	8 422502 72730 8	1x3	4	40	NEW!
White	41090019	8 422502 26448 3	1,5x3	2	40	NEW!
White	41090020	8 422502 01782 9	2x3	2	40	NEW!
Light Yellow	41090004	8 422502 83757 1	1x3	4	40	NEW!
Light Yellow	41090005	8 422502 13798 5	1,5x3	2	40	NEW!
Light Yellow	41090015	8 422502 95044 7	2x3	2	40	NEW!
Light Green	41090001	8 422502 78801 9	1x3	4	40	NEW!
Light Green	41090002	8 422502 06215 7	1,5x3	2	40	NEW!
Light Green	41090007	8 422502 73566 2	2x3	2	40	NEW!
Light Brown	41090021	8 422502 84349 7	1x3	4	40	NEW!
Light Brown	41090022	8 422502 51794 7	1,5x3	2	40	NEW!
Light Brown	41090023	8 422502 00493 5	2x3	2	40	NEW!



E-PLUS Double face | E-PLUS Doppelseitig
E-PLUS Double face | E-PLUS Dwustronna strona

Color	Code	Dimensions	m	Rolls	Rolls
White	42110014	8 422502 89844 2	1x3	4	32
White	42110015	8 422502 83997 1	1,5x3	2	32
White	42110016	8 422502 70409 5	2x3	2	32
Light Yellow	42110004	8 422502 50939 3	1x3	4	32
Light Yellow	42110005	8 422502 02625 8	1,5x3	2	32
Light Yellow	42110006	8 422502 10860 2	2x3	2	32
Light Green	42110001	8 422502 15996 3	1x3	4	32
Light Green	42110002	8 422502 87005 9	1,5x3	2	32
Light Green	42110003	8 422502 10175 7	2x3	2	32
Light Brown	42110017	8 422502 10695 0	1x3	4	32
Light Brown	42110018	8 422502 90153 1	1,5x3	2	32
Light Brown	42110019	8 422502 578559	2x3	2	32

* Il n'est pas recommandé de l'utiliser comme toit ou comme ombrege. Il est uniquement recommandé de l'utiliser en position verticale sur les clôtures, les murs, etc. | We do not recommend its use as a roof or shade. We only recommend its use in vertical position on fences, walls, etc. | Es wird nicht zur Verwendung als Dach oder Schattenspende empfohlen. Es wird nur für die Verwendung in vertikaler Position an Zäunen, Mauern usw. empfohlen | Nie zalecamy używania go jako dachu lub cienia. Zalecamy jego stosowanie tylko w pozycji pionowej na ogrodzeniach, ścianach itp.



Blanc / Weiß / White / Biały

Bambou / Bambus / Bamboo / Bambus

Vert / Grün / Green / Zielony

Marron / Braun / Brown / Brązowy

Anthracite / Anthrazit / Anthracite / Antracyt

Pierre / Steinfarbe / Stone / Kamień



Nouveau pack plié! > Unique dans le marché

Neue Verpackung > Einzigartig am Markt

New folding pack. Unique on the market

Nowe składowane opakowanie! > Nowość na rynku



Canisse PVC Superior 20mm Double face Hochwertige PVC-Sichtschutzmatte Doppelseitig 20mm | Superior PVC Screen 20 mm D/C | Dwustronny PVC 20 mm D/C



- FR** Tiges en plastique de haute qualité, de 20 mm de large, cousus avec du fil de nylon collé sur toutes les tiges et les points. Avec traitement anti-UV.
- DE** 20 mm breite, hochwertige Kunststoffprofile, genäht mit Nylonfaden, der an allen Stäben und Stichen Kunststoffstangen ist. Mit Anti-UV-Behandlung.
- EN** High-quality 20 mm plastic rods, sewn with nylon thread glued to all rods and stitches. With anti-UV treatment.
- PL** Listewki o szerokości 20 mm, wykonane z wysokiej jakości tworzywa sztucznego, połączone nylonową nicią, mocowaną do listew i szwów przy pomocy specjalnego kleju. Odporne na promieniowanie UV.

D/C> Double face | D/C> Doppelseitig
D/C> Double face | D/C> Dwustronna strona

Icon	Code	Product Code	Color	Height (m)	Length	Quantity	Label
○	42010046	8 422502 85118 8	White	0,9x3	4	60	NEW!
○	42010001	8 422502 21003 9	White	1x3	4	64	
○	42010102	8 422502 68675 9	White	1,5x3	2	48	NEW!
○	42010047	8 422502 03532 8	White	1,8x3	2	60	NEW!
○	42010103	8 422502 88354 7	White	2,0x3	2	48	
○	42010006	8 422502 39001 4	White	1x5	2	32	
○	42010012	8 422502 29003 1	White	1,5x5	2	32	
○	42010018	8 422502 30003 7	White	2x5	2	32	
○	42010026	8 422502 59476 4	White	0,9x3	4	60	NEW!
○	42010002	8 422502 21002 2	White	1x3	4	64	
○	42010106	8 422502 97394 1	White	1,5x3	2	48	
○	42010107	8 422502 14840 0	White	1,8x3	2	60	NEW!
○	42010032	8 422502 66072 8	White	2x3	2	48	
○	42010007	8 422502 39002 1	White	1x5	2	32	
○	42010013	8 422502 29002 4	White	1,5x5	2	32	
○	42010019	8 422502 30002 0	White	2x5	2	32	
○	42010052	8 422502 71098 0	White	0,9x3	4	60	NEW!
○	42010005	8 422502 21001 5	White	1x3	4	64	
○	42010048	8 422502 29004 8	White	1,5x3	2	48	
○	42010051	8 422502 48942 8	White	1,8x3	2	60	NEW!
○	42010054	8 422502 38707 6	White	2x3	2	48	
○	42010011	8 422502 39003 8	White	1x5	2	32	
○	42010017	8 422502 29001 7	White	1,5x5	2	32	
○	42010023	8 422502 30001 3	White	2x5	2	32	
○	42010044	8 422502 02324 0	White	0,9x3	4	60	NEW!
○	42010003	8 422502 21027 5	White	1x3	4	64	
○	42010096	8 422502 37270 6	White	1,5x3	2	48	
○	42010045	8 422502 84203 2	White	1,8x3	2	60	NEW!
○	42010098	8 422502 71670 8	White	2x3	2	48	
○	42010008	8 422502 21061 9	White	1x5	2	32	
○	42010014	8 422502 21063 3	White	1,5x5	2	32	
○	42010020	8 422502 21065 7	White	2,0x5	2	36	
○	42010036	8 422502 94605 1	White	0,9x3	4	60	NEW!
○	42010073	8 422502 22529 3	White	1x3	4	64	
○	42010074	8 422502 91584 2	White	1,5x3	2	48	
○	42010075	8 422502 31970 1	White	1,8x3	2	60	NEW!
○	42010076	8 422502 11870 0	White	2x3	2	48	
○	42010151	8 422502 47878 1	White	0,9x3	4	60	NEW!
○	42010154	8 422502 50830 3	White	1x3	4	64	
○	42010155	8 422502 37494 6	White	1,5x3	2	48	
○	42010153	8 422502 93018 0	White	1,8x3	2	60	NEW!
○	42010159	8 422502 70951 9	White	2x3	2	48	



Blanc / Weiß / White / Biały

Bambou / Bambus / Bamboo / Bambus

Vert / Grün / Green / Zielony

Marron / Braun / Brown / Brązowy

Anthraxite / Anthrazit / Anthracite / Antracyt

Pierre / Steinfarbe / Stone / Kamień

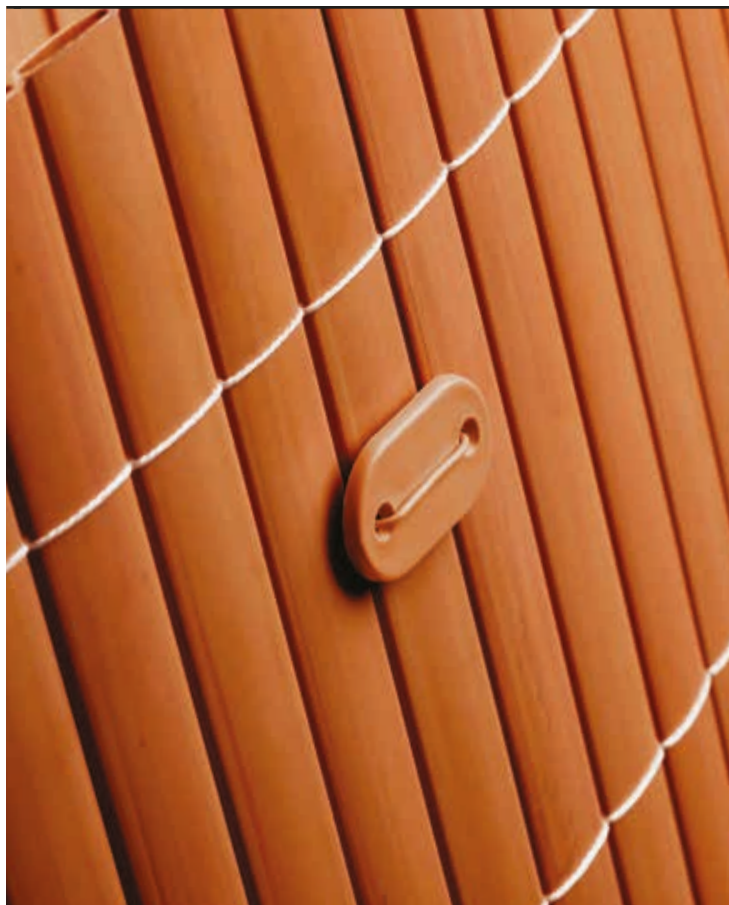

Kit fixation | Befestigungskit
Fixing Kit | Zestaw mocujący z PVC

PACK 26 U.

- FR** Kit d'installation et de fixation des canisses PVC, disponible en différentes couleurs.
- DE** Montageset für die Installation von PVC-Sichtschutz, erhältlich in verschiedenen Farben.
- EN** Assembly kit for the installation of PVC reeds, available in various colours.
- PL** Zestaw montażowy do instalacji stroików z PVC, dostępny w różnych kolorach.

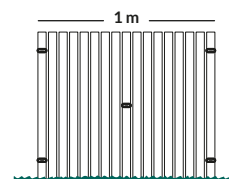

Color	Code	Length	Width	Height	Weight	Quantity
Blanc	48010001	8 422502 69803 5	22x8	50	6750	
Bambou	48010002	8 422502 10539 7	22x8	50	6750	
Vert	48010003	8 422502 18414 9	22x8	50	6750	
Marron	48010004	8 422502 88025 6	22x8	50	6750	
Anthracite	48010007	8 422502 32099 8	22x8	50	6750	
Pierre	48010038	8 422502 14926 1	22x8	50	6750	

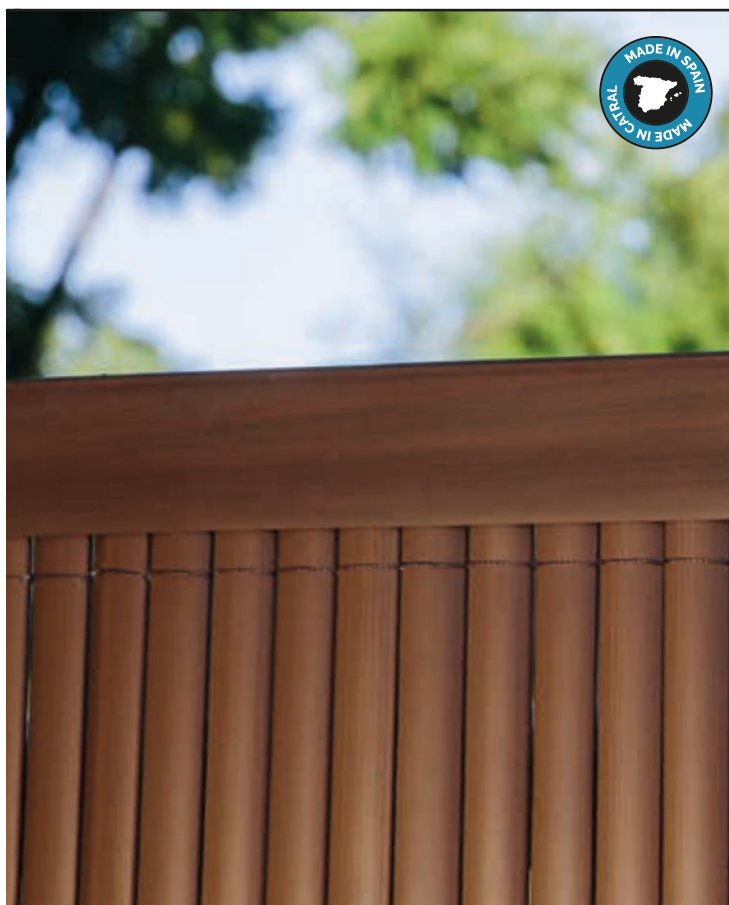

Profils de finition PVC
U-Profile PVC-Sichtschutzmatten
U Profiles PVC Screens
Profile płótkowe w kształcie litery „U” z PCV

PACK 20 U.

- FR** Le profil de finition PVC en forme de U permet d'embellir la canisse destinée à être installée sur terrasses, balcons et jardins.
- DE** Das Abschlussprofil trägt zur Verschönerung des PVC-Rohrgeflechts für die Anbringung auf Terrassen, Balkonen und in Gärten bei.
- EN** The finishing profile helps embellish the PVC screen for installation on terraces, balconies and gardens.
- PL** Listwa wykończeniowa do maty osłonowej PVC, do zastosowania na balkonie, tarasie lub w ogrodzie.



Color	Code	Length	Width	Height	Weight	Quantity
Blanc	42010161	8 422502 52930 8	4,5x3,5x150	1	6240	
Bambou	42010162	8 422502 33303 5	4,5x3,5x150	1	6240	
Vert	42010165	8 422502 62038 8	4,5x3,5x150	1	6240	
Marron	42010163	8 422502 30152 2	4,5x3,5x150	1	6240	
Anthracite	42010160	8 422502 97878 6	4,5x3,5x150	1	6240	
Pierre	42010164	8 422502 02283 0	4,5x3,5x150	1	6240	



Blanc / Weiß / White / Biały

Bambou / Bambus / Bamboo / Bambus

Vert / Grün / Green / Zielony

Marron / Braun / Brown / Brązowy

Anthracite / Anthrazit / Anthracite / Antracyt

Pierre / Steinfarbe / Stone / Kamień



Clôtures écologiques

Lôsier LOP® est une clôture semi-synthétique et écologique, composée de canisses en LOP® (Nom déposé) liées entre elles avec du fil d'acier galvanisé. Il se différencie grâce à son aspect naturel et son haut niveau d'occultation.

- > **Fabrication espagnole** développée dans notre usine CATRAL à Alicante.
- > **Brevet européen**
- > Couleur qui ne s'altère pas grâce au traitement anti-UV
- > Norme ignifuge
- > Homogénéité des canisses
- > Forte occultation et facile à installer

Clôture écologique > Lôsier LOP® fait partie de la gamme de produits éco-responsables de CATRAL. Il est composé de matériel organique et recyclé. A ce jour, 500.000 kg de matériau organique ont été recyclés pour sa fabrication

Design exclusif > Conçu et fabriqué chez CATRAL à Alicante.

LOP® Ökologischer Sichtschutz

LOP®-Sichtschutz ist ein halbsynthetisches und ökologisches Material, in kleine Röhrchen geformt, die mit verzinktem Stahldraht verbunden sind. Es zeichnet sich durch sein natürliches Aussehen und seine Stabilität aus.

- > Die Produkte wurden von **Catral Garden in Alicante** entwickelt
- > **Europäisches Patent**
- > Verliert dank der Anti-UV-Behandlung keine Farbe
- > Das Material ist nur sehr schwer entzündbar
- > LOP® ist sehr flexibel und bricht nicht bei leichten biegen oder drehen. Die Röhren sind durch den verzinkten Stahldraht sehr gut befestigt.
- > Hoher Sichtschutz und einfache Installation

Ökologischer Sichtschutz > Das Weidenrute LOP® gehört zu den umweltfreundlichen Produkten von Catral Garden. Es besteht aus organischem und recyceltem Material. Bis heute wurden mehr als 500.000 Kilogramm organisches Material für seine Herstellung recycelt.

Exklusives design > Design und eigene Herstellung in unserem Hauptsitz in Catral in Alicante.

LOP® Ecological screening

Wicker LOP® is a semisynthetic and ecological product. Wicker Lop form by rods of our new material joined together with galvanised steel. LOP® has a high level of hidden.

- > **Made in Spain:** LOP® has been developed by Catral Garden in Alicante.
- > **European patent**
- > LOP® products keep their colour thanks to the Anti UV treatment.
- > Compliance of control fireproof regulation. LOP® doesn't produce flame.
- > High flexibility level. Wicker LOP® doesn't break with the torsion.
- > High level hidden. Easy process to install.

Ecological screening > Wicker Lop belong to the Eco-friendly products of Catral Garden, it is compound by organic and recycling. Catral Garden has recycled more than 500.000 kg of organic material to produce it.

Exclusive design > Design and manufacture process in our headquarter in Catral, Alicante.

Ogrodzenia ekologiczne

Wiklina LOP® to półsyntetyczna i ekologiczna osłona z prętów wykonanych z naszego najnowszego materiału połączonych stalą ocynkowaną. Wyróżnia się naturalnym wyglądem i wysokim stopniem maskowania.

- > Proces produkcji odbywa się w zakładzie **Catral Garden w Alicante**, w Hiszpanii
- > **Patent europejski**
- > Nie odbarwia się dzięki powłoce chroniącej przed promieniowaniem UV
- > Spełnia warunki przeciwpożarowe, nie wytwarza iskry
- > Bardzo elastyczna. Nie pęka i jest odporna na skręcanie. Jednolite pręty i umiejscowienie drutu z ocynkowanej stali
- > Zapewnia wysoki poziom maskowania i jest łatwa w montażu

Mata ekologiczna > Wiklina LOP® należy do linii produktów ekologicznych firmy Catral Garden wyprodukowanej z materiałów organicznych i pochodzących z recyklingu. Do chwili obecnej do jej produkcji poddano recyklingowi ponad 500.000 kilogramów materii organicznej.

Wyjątkowy design > Własny projekt i produkcja w siedzibie w Catral w Alicante.

Osier écologique LOP®

LOP® Weiden

LOP® Willow

Ekologiczna kratka LOP®

24

Profil de finition "U" LOP®

Abschlussprofil "U"

Profile of auction "U"

"U" Profil ramy LOP®

24

Treillis écologique LOP®

LOP® Ökologische Rankgitter

LOP® Ecological trellis

Ekologiczna kratka LOP®

25

Accessoires LOP®

LOP® Zubehör

LOP® Accessories

Akcesoria LOP®

25



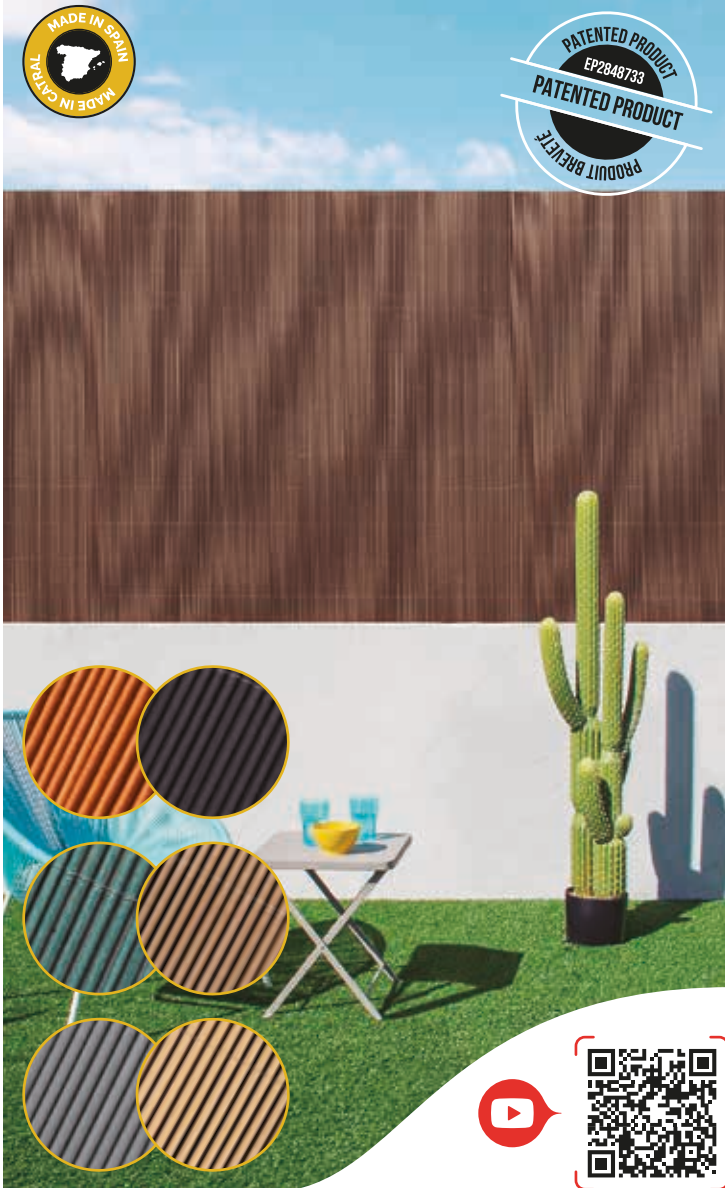

Osier écologique LOP®
LOP® Weiden
LOP® Willow
Ekologiczna kratka LOP®



🔍	📦	📏	m	📦	📦
19010040	8 422502 74314 8	0,9x3	2	28	
19010041	8 422502 22231 5	1x3	2	28	
19010042	8 422502 72578 6	1,5x3	2	28	
19010043	8 422502 03452 9	1,8x3	2	28	
19010044	8 422502 11856 4	2x3	2	28	
19010050	8 422502 69598 0	0,9x3	2	28	
19010051	8 422502 28179 4	1x3	2	28	
19010052	8 422502 46240 7	1,5x3	2	28	
19010053	8 422502 82470 0	1,8x3	2	28	
19010054	8 422502 77561 3	2x3	2	28	
19010055	8 422502 94847 5	0,9x3	2	28	
19010056	8 422502 47695 4	1x3	2	28	
19010057	8 422502 31646 5	1,5x3	2	28	
19010058	8 422502 20797 8	1,8x3	2	28	
19010059	8 422502 33879 5	2x3	2	28	
19010060	8 422502 72585 4	0,9x3	2	28	
19010061	8 422502 97707 9	1x3	2	28	
19010062	8 422502 31490 4	1,5x3	2	28	
19010063	8 422502 59255 5	1,8x3	2	28	
19010064	8 422502 72608 0	2x3	2	28	
19010067	8 422502 40876 4	0,9x3	2	28	
19010068	8 422502 34526 7	1x3	2	28	
19010069	8 422502 65952 4	1,5x3	2	28	
19010070	8 422502 46606 1	1,8x3	2	28	
19010071	8 422502 82070 2	2x3	2	28	
19010072	8 422502 92518 6	0,9x3	2	28	
19010073	8 422502 87299 2	1x3	2	28	
19010074	8 422502 44697 1	1,5x3	2	28	
19010075	8 422502 08012 0	1,8x3	2	28	
19010076	8 422502 38671 0	2x3	2	28	

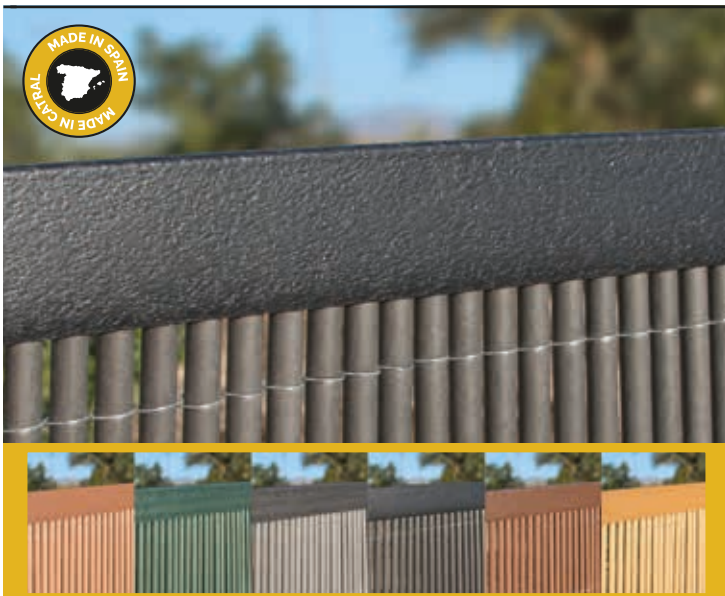

Profil de finition "U" LOP®
Abschlussprofil "U"
Profile of auction "U"
"U" Profil ramy LOP®



🔍	📦	📏	cm	📦	📦
19030001	8 422502 98409 1	2,5/3,5x150	20	4800	
19030002	8 422502 54894 1	2,5/3,5x150	20	4800	
19030003	8 422502 72331 7	2,5/3,5x150	20	4800	
19030004	8 422502 60826 3	2,5/3,5x150	20	4800	
19030005	8 422502 98200 4	2,5/3,5x150	20	4800	
19030006	8 422502 06736 7	2,5/3,5x150	20	4800	

* Il n'est pas recommandé de l'utiliser comme toit ou comme ombrage. Il est uniquement recommandé de l'utiliser en position verticale sur les clôtures, les murs, etc. | Es wird nicht zur Verwendung als Dach oder Schattenspendler empfohlen. Es wird nur für die Verwendung in vertikaler Position an Zäunen, Mauern usw. empfohlen | Nie zalecamy używania go jako dachu lub cienia. Zalecamy jego stosowanie tylko w pozycji pionowej na ogrodzeniach, ścianach itp.

OCCULTATION | SICHTSCHUTZ | PRIVACY | MASKOWANIE



- Osier / Weide / Wicker / Wiklina
- Gris clair / Hellgrau / Light grey / Jasnoszary
- Bois / Holz / Wood / Drewno
- Vert / Grün / Green / Zielony
- Anthracite / Anthrazit / Anthracite / Antracyt
- Bambou foncé / Dunkler Bambus / Dark bamboo / Ciemny bambus



* Profil non inclus | Profile nicht inklusive | Profile not included | Profil niedolaczony w zestawie



Trellis écologique LOP®
LOP® Ökologische Rankgitter
LOP® Ecological trellis
Ekologiczna kratka LOP®



FR Il s'agit d'un treillis en LOP®, un matériau de fabrication 100% espagnole utilisant des matériaux écologiques pour créer un produit résistant, très léger, flexible et d'aspect très naturel.

DE Es ist ein Rankgitter aus LOP®, einem Material aus 100% spanische Herstellung, die ökologische Materialien verwendet ein widerstandsfähiges, sehr leichtes, flexibles und Sehr natürliches Aussehen und Gefühl.

EN Trellis made with LOP®, a 100% Spanish manufacturing material that uses ecological materials to create a resistant product, very light, flexible and with a very natural look and feel.

PL Kratka wykonana z hiszpańskiego tworzywa LOP®, do którego produkcji wykorzystywane są wyłącznie ekologiczne materiały. Rezultatem jest trwały produkt, cechujący się lekkością i elastycznością oraz naturalnym wyglądem.

Icon	Icon	Icon	m	Icon	Icon
🔁	🏠		0,6x1,2	📦	156
🔁	🏠		0,8x1,2	📦	78 NEW!
🔁	🏠		1x2	📦	54
🔁	🏠		0,6x1,2	📦	156
🔁	🏠		0,8x1,2	📦	78 NEW!
🔁	🏠		1x2	📦	54
🔁	🏠		0,6x1,2	📦	156
🔁	🏠		0,8x1,2	📦	78 NEW!
🔁	🏠		1x2	📦	54
🔁	🏠		0,6x1,2	📦	156
🔁	🏠		0,8x1,2	📦	78 NEW!
🔁	🏠		1x2	📦	54



Accessoires LOP® | LOP® Zubehör
LOP® Accessories | Akcesoria LOP®



Profil d'encadrement LOP® | LOP® Rahmenprofil
LOP® Frame profile | Profil ramy LOP®

Icon	Icon	Icon	cm	Icon	Icon
🔁	🏠		200x4,5x2,2	📦	1440
🔁	🏠		200x4,5x2,2	📦	1440
🔁	🏠		200x4,5x2,2	📦	1440
🔁	🏠		200x4,5x2,2	📦	2400

Kit d'encadrement LOP® | LOP® Winkelset für Rahmen
LOP® Frame bracket Kit | Zestaw wsporników ramy LOP®

Icon	Icon	Icon	cm	Icon	Icon
🔁	🏠		4,5x4,5x2	📦	-
🔁	🏠		4,5x4,5x2	📦	-
🔁	🏠		4,5x4,5x2	📦	-
🔁	🏠		4,5x4,5x2	📦	-

4 u.

Kit de séparateurs LOP® | LOP® Rahmen Trennwand Kit
LOP® Frame separators Kit | Kit separatori CORNICIE LOP®

Icon	Icon	Icon	Icon	Icon
🔁	🏠		1	-
🔁	🏠		1	-
🔁	🏠		1	-
🔁	🏠		1	-

8 u.



- Osier / Weide / Wicker / Wiklina
- Bambou / Bambus / Bamboo / Bambus
- Vert / Grün / Green / Zielony
- Anthracite / Anthrazit / Anthracite / Antracyt



Panneau-trellis fixe en PVC Feste PVC-Spalier | Fixed PVC trellis Stała kratka PCV

- FR** Treillis en PVC fabriqués par Catral Garden. Sa variété de tailles de cadre et ses couleurs tendance en font un élément clé pour décorer et séparer les environnements du jardin.
- DE** PVC-Gitter von Catral Garden. Die verschiedenen Rahmengrößen und Trendfarben machen es zu einem Schlüsselement für die Dekoration und Trennung von Umgebungen im Garten.
- EN** PVC trellis made by Catral Garden. Its variety of frame size and trend colors make it a key element to decorate and separate environments in the garden.
- PL** Kratki z tworzywa PCV są produkowane przez firmę Catral Garden. Różne rozmiary ramek w modnych kolorach sprawiają, że jest to kluczowy element dekoracyjny, służący do oddzielenia stref ogrodowych.

Icon	Icon	Icon	m	mm	Icon	Icon
○	43050014	8 422502 21412 9	0,6x1,2	18	6	144
○	43050019	8 422502 61690 9	0,8x1,2	18	6	72 NEW!
○	43050001	8 422502 43218 9	1x2	18	6	54
○	43050006	8 422502 43248 6	1x2	48	6	54
○	43050013	8 422502 79443 0	0,6x1,2	18	6	144
○	43050018	8 422502 29367 4	0,8x1,2	18	6	72 NEW!
○	43050002	8 422502 43118 2	1x2	18	6	54
○	43050007	8 422502 43148 9	1x2	48	6	54
○	43050011	8 422502 54733 3	0,6x1,2	18	6	144
○	43050016	8 422502 31431 7	0,8x1,2	18	6	72 NEW!
○	43050005	8 422502 43018 5	1x2	18	6	54
○	43050009	8 422502 43048 2	1x2	48	6	54
○	43050010	8 422502 21283 5	0,6x1,2	18	6	144
○	43050015	8 422502 19246 5	0,8x1,2	18	6	72 NEW!
○	43050003	8 422502 43119 9	1x2	18	6	54
○	43050008	8 422502 43149 6	1x2	48	6	54
○	43050012	8 422502 64878 8	0,6x1,2	18	6	144
○	43050017	8 422502 14319 1	0,8x1,2	18	6	72 NEW!
○	43050041	8 422502 40973 0	1x2	18	6	60
○	43050042	8 422502 17677 9	1x2	48	6	54



Profils d'union H et de finition U | Abschluss- und Verbindungsprofile | U and H shaped profiles | Profile wykończeniowe i łączące

- FR** Ils aident à donner une finition professionnelle au treillis installé, renforcer sa structure et ses ancrés.
- DE** Sie verhelfen dem installierten Gitter zu einem professionellen Finish. Verstärkung seiner Struktur und Anker.
- EN** This helps to give a professional finish to the trellis, making stronger its structure and anchors.
- PL** Pomagają nadać profesjonalny wygląd zamontowanej kratce, wzmacniając jej konstrukcję i punkty mocowania.

Icon	Icon	Icon	cm	H	Icon	Icon
○	43070001	8 422502 84002 1	212x1,5x1,5	U	20	9750
○	43070006	8 422502 84010 6	205x3,5x1,5	H	10	4600
○	43070002	8 422502 84003 8	212x1,5x1,5	U	20	9750
○	43070007	8 422502 84011 3	205x3,5x1,5	H	10	4600
○	43070005	8 422502 84001 4	212x1,5x1,5	U	20	9750
○	43070010	8 422502 84009 0	205x3,5x1,5	H	10	4600
○	43070003	8 422502 84004 5	212x1,5x1,5	U	20	9750
○	43070008	8 422502 84012 0	205x3,5x1,5	H	10	4600
○	43070004	8 422502 84005 2	212x1,5x1,5	U	20	9750
○	43070009	8 422502 84013 7	205x3,5x1,5	H	10	4600



○ Blanc / Weiß / White / Biały

○ Bambou / Bambus / Bamboo / Bambus

○ Vert / Grün / Green / Zielony

○ Marron / Braun / Brown / Brązowy

○ Anthracite / Anthrazit / Anthracite / Antracyt

○ Noir / Schwarz / Black / Czarny



Trellis extensible en plastique
Ausziehbares Gitter
Extensible plastic trellis
Rozsuwana kratka PCV



- FR** Treillis extensibles en PVC, adaptables à tout espace de la terrasse ou du jardin.
- DE** Ausziehbares Gitter aus PVC, anpassbar an jeden Raum der Terrasse oder des Gartens.
- EN** Extensible trellis made of PVC, adaptable to any space on the terrace or garden.
- PL** Rozsuwane kratki z tworzywa PCV, które pasują do każdej przestrzeni na tarasie lub w ogrodzie



			m	cm		
	43060001	8 422502 33008 9	0,5x1,5	12	12	720
	43060004	8 422502 33010 2	1x2	12	6	546
	43060005	8 422502 33012 6	1x3	12	6	390
	43060002	8 422502 33007 2	0,5x1,5	12	12	720
	43060003	8 422502 33009 6	1x2	12	6	546
	43060006	8 422502 33011 9	1x3	12	6	390

OCCULTATION | SICHTSCHUTZ | PRIVACY | MASKOWANIE

TREILLIS AVEC FEUILLES | RANKGITTER MIT BLÄTTERN | TRELLIS WITH LEAVES | KRATKI Z LIŚĆMI



Trellis extensible érable vert
Ausziehbares Ahornziergitter
Extensible maple trellis
Rozsuwana kratka Zielony Klon



- FR** Treillis extensible en osier, recouvert de feuilles d'érable vertes en plastique. Il crée un aspect feuillu et naturel dans votre maison ou votre jardin.
- DE** Ausziehbares Spalier aus Weidengeflecht, bedeckt mit grünen Ahornblättern aus Kunststoff. Es schafft ein üppiges und natürliches Aussehen in Ihrem Haus oder Garten.
- EN** Extensible wicker trellis, covered with plastic green maple leaves. It generates a lush and natural look in your home or garden.
- PL** Rozsuwane kratki wiklinowe z dekoracją z zielonych liści klonu, wykonanych z tworzywa sztucznego, to bujny, naturalny wygląd dla Twojego domu lub ogrodu.



			m		
	43040019	8 422502 25852 9	1x1,5	5	80



- Blanc / Weiß / White / Biały
- Vert / Grün / Green / Zielony



Trellis extensible CYPRÈS
Zypressenziergitter
Extensible CYPRUS trellis
Rozsuwana kratka CYPRYS



FR Treillis extensibles en osier, garnis de feuilles de cyprès imitant l'aspect naturel afin de décorer, cloisonner et créer des ambiances naturelles.

DE Ausziehbares Weidengitter mit Zypressenblättern. Durch das natürliche Aussehen ist es perfekt um dekorieren, abtrennen und zum Schaffen von natürlicher Umgebung geeignet.

EN Extensible willow fence, relaves with cypress leaves creating a natural look to decorate, separate and to create natural environments.

PL Rozsuwana kratka wiklinowa z liśćmi cyprysu służąca do dekoracji, oddzielania stref i tworzenia naturalnie wyglądających przestrzeni.



📦	📏	m	📄	🚚
43040021	8 422502 34928 9	1x1,5	5	45

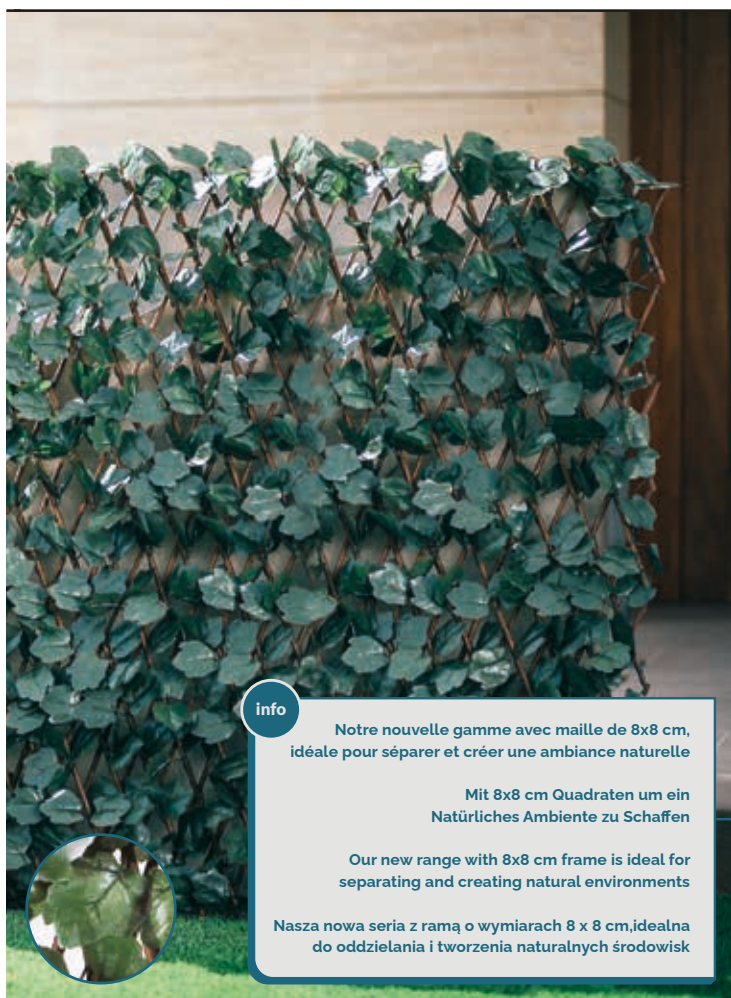

Trellis extensible avec feuilles
Rankgitter mit Blättern
Extensible trellis with leaves
Rozsuwana kratka z liśćmi



FR Nouvelle gamme de treillis décoratifs à feuilles. La composition des feuilles permet à la fois de cacher et de créer un espace décoratif sur la terrasse ou le jardin.

DE Neues Sortiment an dekorativen Rankgitter mit Blättern. Die Zusammensetzung der Blätter ermöglicht sowohl das Verstecken als auch die Schaffung eines dekorativen Raums auf der Terrasse oder im Garten.

EN New range of decorative lattice with leaves. The composition of the leaves allows both concealing and creating a decorative space on the terrace or garden.

PL Nowa gama ozdobnych krutek z liśćmi. Kompozycja z liści zapewnia efekt maskujący i umożliwia udekorowanie przestrzeni na tarasie lub w ogrodzie.



info

Notre nouvelle gamme avec maille de 8x8 cm, idéale pour séparer et créer une ambiance naturelle

Mit 8x8 cm Quadraten um ein Natürliches Ambiente zu Schaffen

Our new range with 8x8 cm frame is ideal for separating and creating natural environments

Nasza nowa seria z ramą o wymiarach 8 x 8 cm, idealna do oddzielania i tworzenia naturalnych środowisk

BASIC

📦	📏	m	n.🍃	📄	🚚
43040032	8 422502 92878 1	1x2	350	5	90
43040033	8 422502 62997 8	1x3	484	5	90
📦	📏	m	n.🍃	📄	🚚
43040008	8 422502 33018 8	1x2	412	5	75
43040007	8 422502 33017 1	1x3	638	5	80



Trellis extensible avec feuilles LEVEL
Ausziehbares Rankgitter mit LEVEL-
Blättern | LEVEL Extensible trellis with leaves
Rozsuwana kratka z liśćmi LEVEL

- FR** Nouvelle gamme de treillis décoratifs à feuilles. La conception et la forme des feuilles permet à la fois de cacher et de créer un espace décoratif sur la terrasse ou le jardin.
- DE** Neues Sortiment an dekorativen Rankgitter mit Blättern. Die Zusammensetzung der Blätter ermöglicht sowohl das Verstecken als auch die Schaffung eines dekorativen Raums auf der Terrasse oder im Garten
- EN** New range of decorative lattice with leaves. The composition of the leaves allows both concealing and creating a decorative space on the terrace or garden.
- PL** Nowy model ozdobnej kratki ze wzmocnionymi, bardzo trwałymi liśćmi, które nie opadają i nie niszczą z upływem czasu. Kompozycja z liści zapewnia efekt maskujący i umożliwia udekorowanie przestrzeni na tarasie lub w ogrodzie.

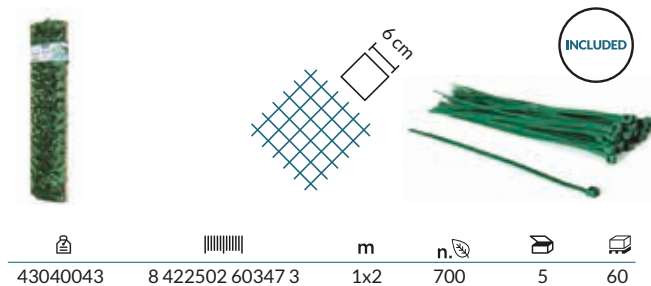

📦	📏	m	n. 🌿	📦	🚚
43040043	8 422502 60347 3	1x2	700	5	60

TREILLIS EN OSIER | WEIDENRUTENGITTER | WICKER TRELIS | WIKLINOWE KRATOWNICE



Trellis extensible en osier
Ausziehbares Weidenrutengitter
Extensible willow trellis
Rozsuwane kratki z wikliny

- FR** Trellis en osier de haute qualité pour séparer les environnements ou créer des espaces décoratifs.
- DE** Hochwertiges Ausziehbares Weidenrutengitter zur Trennung von Umgebungen oder zur Schaffung dekorativer Räume.
- EN** High quality willow trellis for separating environments or creating decorative spaces.
- PL** Rozsuwana przegroda wykonana z wysokiej jakości prętów wiklinowych, idealna do oddzielania stref lub dekorowania przestrzeni w ogrodzie.

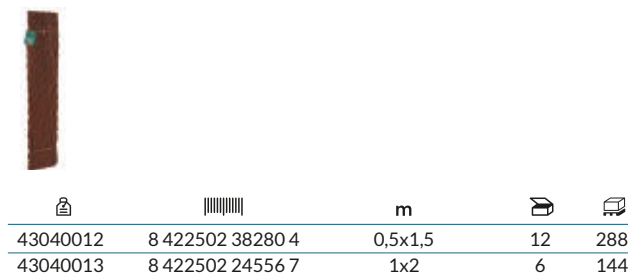

📦	📏	m	📦	🚚
43040012	8 422502 38280 4	0,5x1,5	12	288
43040013	8 422502 24556 7	1x2	6	144



Haies artificielles

Idéal pour l'occultation des jardins ou terrasses, développé avec des fibres de dernière génération. Aspect très naturel, dense et homogène pour un très haut niveau d'occultation.

Haute occultation et protection UV

Grâce au traitement anti-UV et à ses matières premières de haute qualité, la longévité est assurée et la couleur tient dans le temps.

Künstliche Hecken

Ideal zum verbergen von Gärten und Räumen, entwickelt mit Fasern der letzten Generation, schafft ein natürliches, grünes, homogenes Aussehen homogenes Aussehen, welches hohes Niveau an Sichtschutz garantiert.

Hohe Privatsphäre und UV-Schutz

Dank der Anti-UV-Behandlung und ihrer Zusammensetzung, verliert das Produkt nicht seine ursprüngliche Farbe und garantiert maximale Stabilität.

Artificial hedges

Perfect for garden privacy or any other space, developed with the latest fibres. It creates a natural appearance with uniform colours that guarantees high level of screening.

High privacy and UV protection

Thanks to its anti-UV treatment, it does not lose its original colour and guarantees highest stability.

Sztuczne żywopłoty

Idealne, aby odgradzić i osłonić ogrody i inne strefy. Wyprodukowane z włókien ostatniej generacji, które zapewniają naturalny i bujny wygląd o jednolitym kolorze oraz maksymalny poziom maskowania.

Wysoki poziom maskowania i ochrona przed promieniowaniem UV

Skład i powłoka chroniąca przed promieniowaniem UV sprawiają, że nie tracą pierwotnego koloru i gwarantują maksymalną stabilność.

Haies artificielles
Künstliche Hecken
Artificial hedges
Sztuczne żywopłoty

32





La haie fabriquée à Catral

Les haies Hidenatur sont fabriquées chez Catral et ont la garantie d'être de fabrication nationale, avec des résultats d'une qualité optimale et offrant un haut niveau de dissimulation et de résistance.

Die Hecke aus Catral

Die Hecken von Hidenatur werden in Catral hergestellt und haben die Garantie, dass sie auf nationaler Ebene hergestellt werden, mit optimalen Qualitätsergebnissen und einem hohen Maß an Sichtschutz und Beständigkeit.

Hedges made at Catral

Hidenatur hedges are manufactured at Catral and have the guarantee of being made in Spain, with optimum quality results and offering a high level of masking and strength.

Sztuczny żywopłot Catral

Sztuczny żywopłot Hidenatur wyprodukowany w Hiszpanii przez firmę Catral, gwarantuje najwyższą jakość, maksymalne krycie i trwałość.



Haie HIDENATUR | Kunsthäcke HIDENATUR HIDENATUR Hedge | Żywopłot HIDENATUR

- FR** Haie de 36 tiges fabriquée chez Catral Garden et développée avec des fibres de dernière génération dans des tons très naturels, garantissant par son aspect feuillu et homogène un haut niveau d'occultation.
- DE** 36-Stab-Hecke, hergestellt in Catral Garden und entwickelt mit Fasern der letzten Generation, die einen sehr natürlichen, blättrigen und homogenen Farbton erzeugen, der ein hohes Maß an Sichtschutz garantiert.
- EN** 36 lines hedge made in Catral Garden and developed with the latest generation of fibres creating a very natural, leafy and homogeneous tones that guarantee a high level of concealment
- PL** Zabezpieczenie 36 prętów wykonanych w Catral Garden i opracowanych z włókien ostatniej generacji tworząc bardzo naturalne, liściaste i jednorodne odcienie, które gwarantuje wysoki poziom ukrycia.

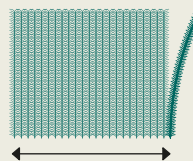

Hidenatur

1 m = 36 tiges / 36 Stäbe / 36 lines / 36 prętów

🏠	📏	m	📦	🚚
43080003	8422502 64058 4	1x3	36	1 56
43080004	8422502 09849 1	1,5x3	36	1 56
43080005	8422502 82077 1	2x3	36	1 56





PLUS

**Haie HIDENATUR PLUS | Kunsthäcke HIDENATUR PLUS
HIDENATUR PLUS Hedge | Żywopłot HIDENATUR PLUS**



- FR** Haie fabriquée chez Catral Garden et développée avec des fibres de dernière génération dans des tons très naturels et homogènes. Ses 40 tiges par mètre lui procurent niveau d'occultation particulièrement élevé.
- DE** 40-Stab-Hecke, hohe Qualität, hergestellt in Catral Garden, entwickelt mit Fasern der neuesten Generation, die ein sehr natürliches aussehen geben. Sehr natürliche, üppige und homogene Farbtöne, die ein Höchstmaß an Sichtschutz garantieren.
- EN** High quality 40 lines hedge, manufactured in Catral Garden and developed with the latest generation of fibres, creating a very natural and leafy appearance with homogeneous tones that guarantees a maximum level of privacy.
- PL** Wysokiej jakości żywopłot 40-prętów, produkowany w Catral Garden i opracowany przy użyciu najnowszej generacji włókien, tworzących bardzo naturalny, liściasty wygląd o jednorodnych odcieniach, który gwarantuje maksymalny poziom ukrycia.

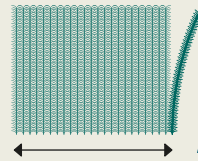

Hidenatur Plus

1 m = 40 tiges / 40 Stäbe / 40 lines / 40 prętów

🏠		m	🧱	📏	📦
43080006	8422502 46613 9	1x3	40	1	56
43080007	8422502 86247 4	1,5x3	40	1	56
43080008	8422502 30689 3	2x3	40	1	56





Haie BASIC | Kunsthecke
BASIC | BASIC Hedge
Żywopłot BASIC



- FR** Haie de 30 tiges, feuillues d'aspect naturel.
- DE** 30-stämmige Hecke, sehr natürlich aussehende, belaubte und homogene Farbtöne.
- EN** 30 rods hedge, very natural and leafy appearance with homogeneous tones.
- PL** 30 pręty żywopłotu, bardzo naturalny i liściasty wygląd z jednorodnych odcieniach.

🏠	📏	m	📦	📄	🚚
43030008	8 422502 79015 9	1x3	30	2	64
43030007	8 422502 79025 8	1,5x3	30	2	64



Haie STANDARD | Kunsthecke
STANDARD | STANDARD Hedge
Żywopłot STANDARD



- FR** Haie bicolore à 36 tiges, très naturelle. Niveau intermédiaire d'occultation.
- DE** Zweifarbige Hecke mit 36 Stäben, sehr natürlich aussehend. Mittlerer Grad an Sichtschutz dank der Anzahl der Stäbe.
- EN** Two-coloured hedge with 36 rods, very natural appearance. Average level of concealment thanks to the number of lines.
- PL** Dwukolorowe żywopłot z 36 prętami, bardzo naturalny wygląd. Średni poziom ukrywania dzięki liczbie linii.

🏠	📏	m	📦	📄	🚚
43020001	8 422502 79010 4	1x3	36	2	64
43020002	8 422502 79020 3	1,5x3	36	2	64
43020003	8 422502 79022 7	2x3	36	2	48



Haie FINE | Kunsthecke „FINO”
FINO Hedge | Żywopłot FINE



- FR** Haie bicolore avec 36 tiges, idéale pour créer des environnements frais et naturels dans les piscines, les jardins et les terrasses.
- DE** Zweifarbige Hecke mit 36 Stöcken, ideal zur Schaffung frischer und natürlicher Umgebungen in Schwimmbädern, Gärten und Terrassen.
- EN** Two-coloured hedge with 36 rods, ideal for creating fresh and natural environments in swimming pools, gardens and terraces.
- PL** Dwukolorowe żywopłot z 36 wędziskami, idealny do tworzenia świeżych i naturalnych środowisk w basenach, ogrodach i tarasach.

🏠	📏	m	📦	📄	🚚
43020004	8 422502 79050 0	1x3	36	2	48
43020005	8 422502 79060 9	1,5x3	36	2	48
43020006	8 422502 79062 3	2x3	36	2	48



Haie DENSE | Kunsthecke DENSE
DENSE Hedge | Żywopłot DENSE



- FR** Haie de 42 tiges, développée avec la dernière génération de fibres pour générer une haie bicolore d'un feuillage luxuriant maximal.
- DE** 42-strängige Hecke, die mit der neuesten Generation von Fasern entwickelt wurde, um eine zweifarbige Hecke von maximaler Fülle zu erzeugen.
- EN** 42 rods hedge, developed with the latest generation of fibres to generate a two-colour hedge of maximum luxuriance.
- PL** Hedge 42 pręty, opracowane z włókien ostatniej generacji do generowania dwukolorowy żywopłotu maksymalnej liściowości.

		m			
43020013	8 422502 90859 2	1x3	42	2	64
43020014	8 422502 73376 7	1,5x3	42	2	64
43020015	8 422502 14202 6	2x3	42	2	64



Haie EXCEL | EXCEL Kunsthecke
EXCEL Hedge | Żywopłot EXCEL



- FR** Haie bicolore tissée sur un maillage en losange qui garantit un très haut niveau d'occultation.
- DE** Zweifarbige Kunsthecke, die auf einem rhombischen Netz gewebt ist und ein sehr hohes Maß an Sichtschutz garantiert.
- EN** Bicolor hedge woven on a rhombic mesh which guarantees a very high level of concealment.
- PL** Dwukolorowy żywopłot na kwadratowej siatce, który gwarantuje bardzo wysoki poziom maskowania.



		m		
43020007	8 422502 79063 0	1x3	2	36
43020008	8 422502 79064 7	1,5x3	2	36



Haie HEDRA | HEDRA
Kunsthecke | HEDRA Hedge
Żywopłot HEDRA



- FR** Haie bicolore de tons homogènes. Option idéale pour l'occultation des clôtures grâce à l'aspect très naturel de ses feuilles.
- DE** Zweifarbige Kunsthecke von homogenen Tönen. Ideale Option zum Verbergen in Zäunen dank der Veredelung der Blätter.
- EN** Bicolor hedge of homogeneous tones. Ideal option for concealment in fences thanks to the finishing of its leaves.
- PL** Dwukolorowy żywopłot w jednolitym kolorze. Wykończenie z liści zapewnia doskonały efekt maskujący.



		m		
43020012	8 422502 79066 1	1x3	4	64
43020011	8 422502 79067 8	1,5x3	4	64

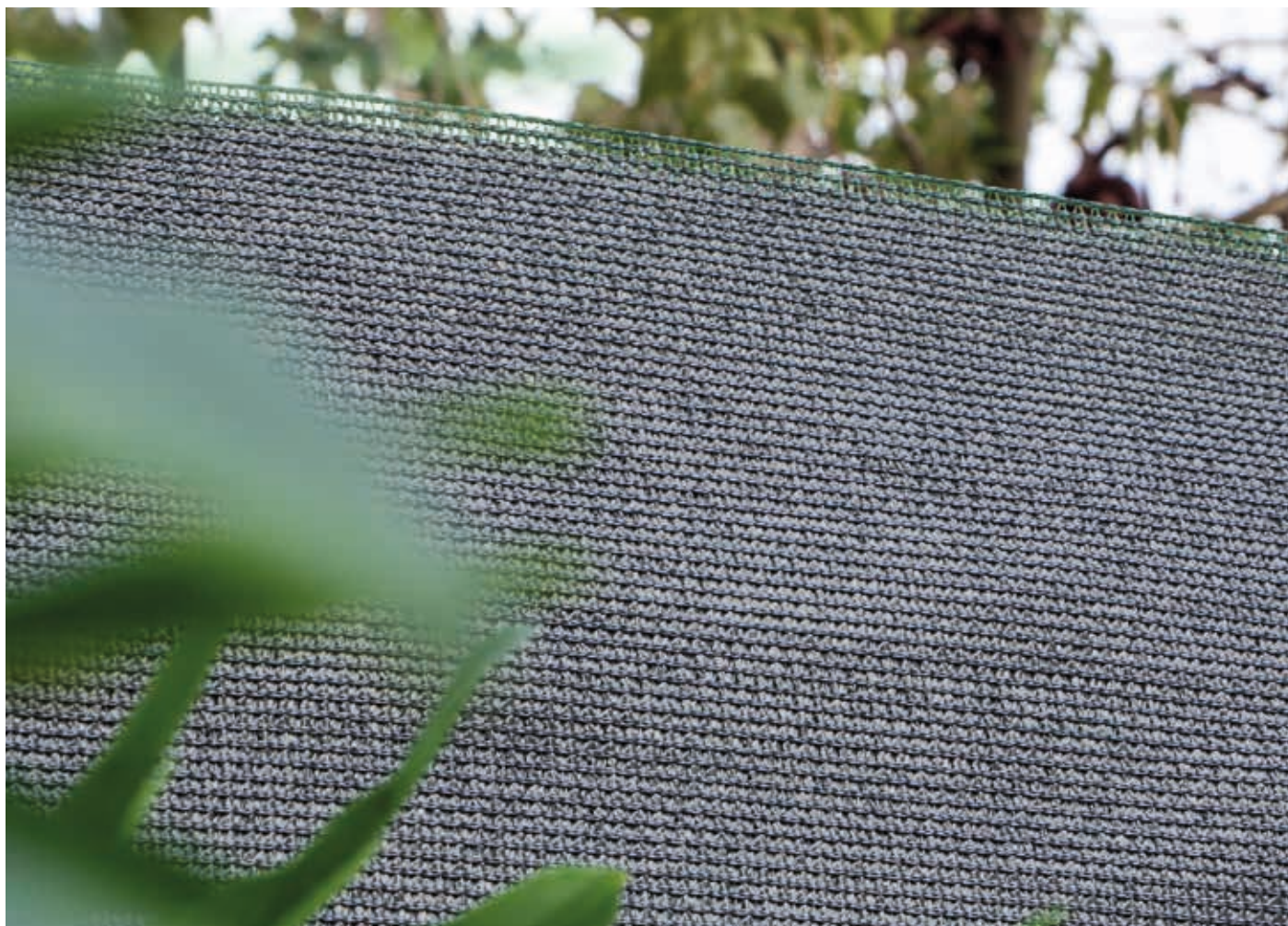

Nattes Brise-vue, d'ombrage et de protection

Nouvelle gamme de couleurs en Brise-vue. Des couleurs tendance pour une des gammes les plus complètes du marché.

Installation facile

Grâce aux boutons incluses dans les liserés, pour les gammes 160 g et Balcony.

Haute résistance

Excellente résistance à l'eau et au soleil grâce à son traitement anti-UV.

Schattierungs-, Verdeck- und Schutzgewebe

Wir präsentieren unsere neueste Farbkollektion bei unseren Balkonbespannungen.

Einfache Installation

Einfache Installation und vorgefertigte Ösen. Die neue 160gr. Version der "Balcony" Kollektion.

Wasserabweisend und UV-Beständig

Sie sind dank der Anti-UV-Behandlung beständig gegen Wasser und Sonne.

Shaded, privacy and protective meshes

We present our new range of colours in privacy meshes. Colour trends for the widest range of the market.

Easy installation

Easy installation and eyelets included in 160gr Privacy Range and Balcony Collection.

High resistance

Highest water resistance to the sun thanks to its anti-UV treatment.

Cieniowane, ukryte i ochronne siatki

Przedstawiamy gamę siatek maskujących w nowych kolorach. Oferujemy najmodniejszą ofertę kolorystyczną na rynku.

Łatwy montaż

Łatwa instalacja i przelotki zawarte w linii 16-gramowych siatek maskujących i kolekcji Balcony.

Wysoka odporność

Maksymalna odporność na wodę i na słońce dzięki powłoce chroniącej przed promieniowaniem UV.

Brise Vue
Sichtschutzgewebe
Privacy meshes
Siatki maskujące

38

Moustiquaires et grillages
Sicherheitsnetze
Protective meshes
Siatki ochronne

45





MESHNET Brise vue 70 g/m²
MESHNET Schattiergewebe
70 g/m² | MESHNET 70 g/m²
Shade cloth | MESHNET Siatka cieniująca 70 g/m²



- FR** Nattes brise-vue résistantes idéales pour aménager un espace à l'abri des regards ou une zone ombragée. Fabriquées en polyéthylène haute densité, avec protection anti-UV.
- DE** Starke Netze für Bereiche mit hohen Windlasten. Material: stabiles Polyethylen mit UV - Schutz behandelt.
- EN** Resistant meshes, made of high density polyethylene with anti-UV protection. Its fitting depends on the required use: privacy or shade.
- PL** Odporne siatki z gęstego polietylenu z powłoką chroniącą przed promieniowaniem UV. Ich lokalizacja będzie zależeć od zastosowania: maskujące lub ocieniające.

🔄	🏠		m	📦	🚚
53010008	8422502	85300 7	2x5	6	210
53010011	8422502	85305 2	3x4	6	210
53010013	8422502	85310 6	4x5	9	225
53010006	8422502	46001 4	1,5x100	1	36
53010007	8422502	46005 2	2x100	1	16



MESHNET Brise vue 90 g/m²
MESHNET Schattiergewebe
90 g/m² | MESHNET 90 g/m²
Shade cloth | MESHNET Siatka cieniująca 90 g/m²



- FR** Nattes brise-vue résistantes idéales pour aménager un espace à l'abri des regards ou une zone ombragée. fabriquées en polyéthylène haute densité, avec protection anti-UV.
- DE** Extrem starke Ausführung für Bereiche mit sehr hohen Windlasten.
- EN** Resistant meshes, perfect for windy areas with high stability and privacy, made of high density polyethylene, anti-UV protection.
- PL** Wytrzymałe siatki idealne do wietrznych stref, o dużej stabilności i wysokim poziomie maskowania, wykonane z gęstego polietylenu z powłoką chroniącą przed promieniowaniem UV.

🔄	🏠		m	📦	🚚
53010025	8422502	85315 1	1x10	6	180
53010028	8422502	85320 5	1,5x10	6	180
53010031	8422502	85325 0	2x10	6	60
53010015	8422502	46030 4	1x100	1	25
53010017	8422502	46035 9	1,5x100	1	25
53010019	8422502	46040 3	2x100	1	16
53010021	8422502	46045 8	3x100	1	9
53010023	8422502	46050 2	4x100	1	9



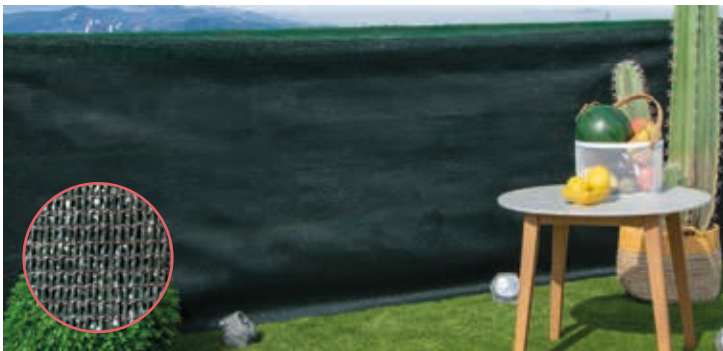

MESHNET Brise-vue 120 g/m²
MESHNET Schattiergewebe 120 g/m²
MESHNET Privacy mesh 120 g/m²
MESHNET Siatka maskująca 120 g/m²



- FR** Maille résistante, idéale pour les zones venteuses. Haute stabilité et occultation, en polyéthylène haute densité, avec protection UV.
- DE** Widerstandsfähiges Meshnet- Schattiergewebe, ideal für Windbereiche mit hoher Stabilität und Abdeckung, aus Polyethylen und mit UV-Schutz.
- EN** Resistant mesh, ideal for wind areas with high stability and concealment, made of high density polyethylene, with UV protection.
- PL** Wytrzymałe siatki idealne do wietrznych stref, o dużej stabilności i wysokim poziomie maskowania, wykonane z gęstego polietylenu z powłoką chroniącą przed promieniowaniem UV.

🔄	📦	📏	m	📦	🚚
🟤	53010050	8 422502 85365 6	1x10	6	180
🟤	53010061	8 422502 85385 4	1,5x10	6	180
🟤	53010073	8 422502 85405 9	2x10	6	60
🟤	53010034	8 422502 46115 8	1x50	1	36
🟤	53010038	8 422502 46135 6	1,5x50	1	36
🟤	53010042	8 422502 46155 4	2x50	1	16
🟤	53010046	8 422502 46175 2	3x50	1	16
🟡	53010052	8 422502 85360 1	1x10	6	180
🟡	53010064	8 422502 85380 9	1,5x10	6	180
🟡	53010075	8 422502 85400 4	2x10	6	60
🟡	53010035	8 422502 46110 3	1x50	1	36
🟡	53010039	8 422502 46130 1	1,5x50	1	36
🟡	53010043	8 422502 46150 9	2x50	1	16
🟡	53010047	8 422502 46170 7	3x50	1	16
🟢	53010054	8 422502 85350 2	1x10	6	180
🟢	53010066	8 422502 85370 0	1,5x10	6	180
🟢	53010078	8 422502 85390 8	2x10	6	60
🟢	53010036	8 422502 46100 4	1x50	1	36
🟢	53010040	8 422502 46120 2	1,5x50	1	36
🟢	53010044	8 422502 46140 0	2x50	1	16
🟢	53010048	8 422502 46160 8	3x50	1	16
🟢	53010057	8 422502 85355 7	1x10	6	108
🟢	53010070	8 422502 85375 5	1,5x10	6	108
🟢	53010081	8 422502 85395 3	2x10	6	60
🟢	53010037	8 422502 46105 9	1x50	1	36
🟢	53010041	8 422502 46125 7	1,5x50	1	36
🟢	53010045	8 422502 46145 5	2x50	1	16
🟢	53010049	8 422502 46165 3	3x50	1	16
🟣	53030067	8 422502 42290 6	1x10	6	108
🟣	53030068	8 422502 93501 7	1,5x10	6	108



🟤 Brande/Heide/Heather/Heather
 🟡 Beige/Bambus/Bamboo/Bamboo

🟢 Vert/Grün/Green/Zielony
 🟣 Vert foncé/Dunkelgrün/Dark green/Ciemnozielony

🟤 Anthracite/Anthrazit/Anthracite/Antracyt



OCCULTATION | SICHTSCHUTZ | PRIVACY | MASKOWANIE

Les Brise-vue Meshmet 160grs sont équipés d'œillets qui facilitent le montage et garantissent une excellente résistance au vent | Unsere neuen Maschen haben Anhänger, die eine exzellente Windstärke gewährleisten | Our new meshes include eyelets that guarantee excellent wind resistance | Nasze nowe siatki mają w zestawie przelotki, które zapewniają doskonałą odporność na wiatr.



MESHNET Brise-vue 160 g/m²
MESHNET Schattiergewebe 160 g/m²
MESHNET Privacy mesh 160 g/m²
MESHNET Siatka maskująca 160 g/m²



- FR** Occultation maximale et grande stabilité pour ces brise vues de haute qualité fabriqués en polyéthylène haute densité avec protection anti-UV. Les couleurs tendance offrent un design attrayant et innovant dans cette nouvelle gamme de mailles. Les boutonsnières sont incluses pour une installation plus facile.
- DE** Stabiles Gewebe das einen hervorragenden Sichtschutz bietet. Hergestellt aus Polyethylen mit UV - Schutz behandelt. Mit neuem Design. Inklusive Befestigungskits zur einfachsten Installation.
- EN** Highest privacy meshes with stability, made of high density polyethylene with anti-UV protection. Created in all trendy colours to offer an attractive and new range of meshes. Eyelets included for an easy installation.
- PL** Siatka zapewniająca wysoką stabilność i maksymalny poziom maskowania, wykonana z polietylenu o dużej gęstości z powłoką chroniącą przed promieniowaniem UV. Nasza nowa linia siatek w najmodniejszych kolorach charakteryzuje się innowacyjnym designem. W zestawie przelotki ułatwiające instalację.



Color	Product Code	Reference	Width (m)	Height (m)	Length (m)	Area (m ²)
Green	53060006	8 422502 97173 2	1x3	9	180	27
Green	53060007	8 422502 80476 4	1,5x3	9	180	40,5
Green	53060009	8 422502 55609 0	2x3	9	180	54
Green	53060001	8 422502 74428 2	1x10	4	80	4
Green	53060002	8 422502 07771 7	1,5x10	4	80	6
Green	53060012	8 422502 66333 0	2x10	4	100	8
Green	53060014	8 422502 36933 1	1x25	1	42	25
Green	53060015	8 422502 13888 3	1,5x25	1	42	37,5
Green	53060017	8 422502 89755 1	2x25	1	42	50
Brown	53060019	8 422502 63586 3	1x3	9	180	27
Brown	53060020	8 422502 80757 4	1,5x3	9	180	40,5
Brown	53060022	8 422502 48309 9	2x3	9	180	54
Brown	53060003	8 422502 79660 1	1x10	4	80	4
Brown	53060004	8 422502 99782 4	1,5x10	4	80	6
Brown	53060026	8 422502 58259 4	2x10	4	100	8
Brown	53060028	8 422502 31372 3	1x25	1	42	25
Brown	53060029	8 422502 37136 5	1,5x25	1	42	37,5
Brown	53060024	8 422502 98125 0	2x25	1	42	50
Grey	53060032	8 422502 38498 3	1x3	9	180	27
Grey	53060033	8 422502 17260 3	1,5x3	9	180	40,5
Grey	53060035	8 422502 33037 9	2x3	9	180	54
Grey	53060037	8 422502 06541 7	1x10	4	80	4
Grey	53060038	8 422502 33986 0	1,5x10	4	80	6
Grey	53060040	8 422502 39788 4	2x10	4	100	8
Grey	53060042	8 422502 73373 6	1x25	1	42	25
Grey	53060043	8 422502 55382 2	1,5x25	1	42	37,5
Grey	53060045	8 422502 35611 9	2x25	1	42	50
Grey	53060062	8 422502 44588 2	1x3	9	180	27
Grey	53060063	8 422502 08770 9	1,5x3	9	180	40,5
Grey	53060065	8 422502 34027 9	2x3	9	180	54
Grey	53060067	8 422502 89066 8	1x10	4	80	4
Grey	53060068	8 422502 81512 8	1,5x10	4	80	6
Grey	53060070	8 422502 19861 0	2x10	4	100	8
Grey	53060072	8 422502 55740 0	1x25	1	42	25
Grey	53060073	8 422502 43049 9	1,5x25	1	42	37,5
Grey	53060075	8 422502 43351 3	2x25	1	42	50

- Vert - olive / Olivgrün / Olive Green / Oliwkowa zieleni
- Marron / Braun / Brown / Brązowy
- Anthracite / Anthrazit / Anthracite / Antracyt
- Pierre / Steinfarbe / Stone / Kamień

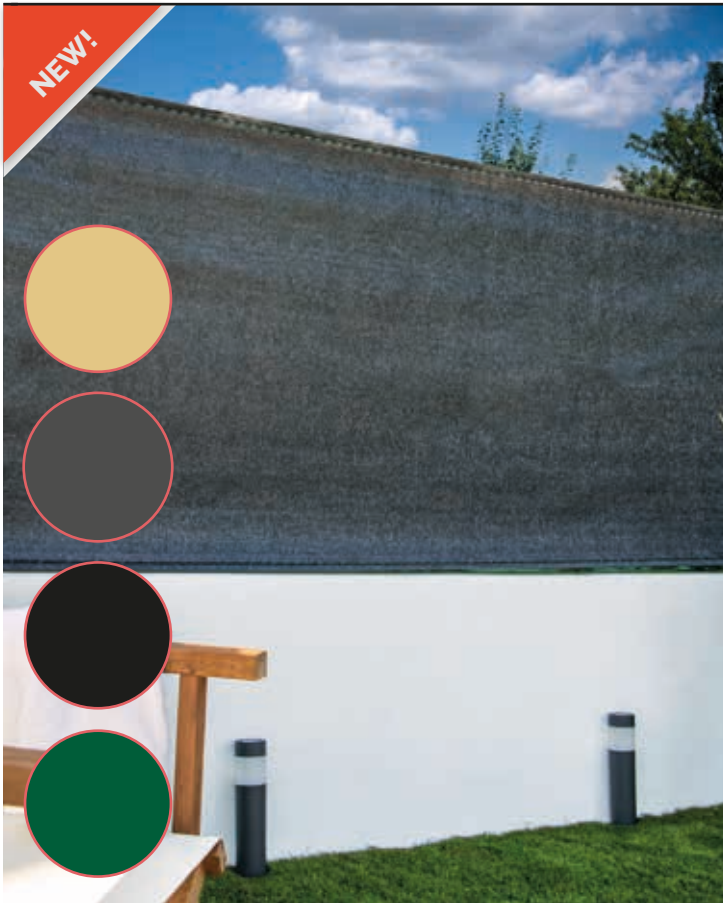

MESHNET Brise-vue 200 g/m²
MESHNET Schattiergewebe 200 g/m²
MESHNET Privacy mesh 200 g/m²
MESHNET Siatka maskująca 200 g/m²



- FR** Maille très résistante, idéale pour les zones venteuses. Haute stabilité et excellente occultation, en polyéthylène haute densité, avec protection UV.
- DE** Widerstandsfähiges Meshnet- Schattiergewebe, ideal für Windbereiche mit hoher Stabilität und Abdeckung, aus Polyethylen und mit UV-Schutz.
- EN** Resistant mesh, ideal for wind areas with high stability and concealment, made of high density polyethylene, with UV protection.
- PL** Wytrzymałe siatki idealne do wietrznych stref, o dużej stabilności i wysokim poziomie maskowania, wykonane z gęstego polietylenu z powłoką chroniącą przed promieniowaniem UV.

🔄	🏠		m	📦	🚚	
🟡	53070006	8 422502 95684 5	1x3	16	192	NEW!
🟤	53070004	8 422502 17168 2	1x3	16	192	NEW!
⬛	53070008	8 422502 57020 1	1x3	16	192	NEW!
🟢	53070002	8 422502 41834 3	1x3	16	192	NEW!
🟡	53070007	8 422502 58184 9	1,5x3	12	72	NEW!
🟤	53070005	8 422502 05433 6	1,5x3	12	72	NEW!
⬛	53070009	8 422502 50527 2	1,5x3	12	72	NEW!
🟢	53070003	8 422502 46622 1	1,5x3	12	72	NEW!



Brise-vue Balcony EASY 160 g/m²
Balkonbespannung EASY 160 g/m²
Balcony EASY Net 160 g/m²
Siatka Balcony EASY 160 g/m²



- FR** Brise-vue en polyéthylène haute densité. Oeillets de fixation en aluminium de 10 mm, situés tous les 50 cm. Liserés renforcés. Traitement anti-UV pour la protection des couleurs.
- DE** Hergestellt aus extrem dichtem Polyethylen. Befestigungsösen, hergestellt aus 10 mm Aluminium in 50 cm Abständen. Verstärkung an den Netzenden. Farb-schutz durch Anti-UV Behandlung.
- EN** High density polyethylene privacy mesh. 10 mm aluminum fixing eyelets every 50 cm. Reinforced at the ends of the mesh. Anti-UV treatment for colour protection.
- PL** Siatka wykonana z polietylenu o dużej gęstości. Przelotki mocujące wykonane z aluminium 10 mm, rozmieszczone co 50 cm. Ze wzmocnieniami na końcach i powłoką UV, która chroni przed wyblaknięciem koloru.

🔄	🏠		m	📦	🚚	
🟤	53040003	8 422502 09232 1	0,9x5	6	120	
🟡	53040002	8 422502 74321 6	0,9x5	6	120	
🟢	53040001	8 422502 88725 5	0,9x5	6	120	
🟢	53040006	8 422502 50274 5	1x25	2	16	
🟢	53040013	8 422502 80168 8	1,5x25	2	16	
⬛	53040004	8 422502 23552 0	0,9x5	6	120	
🟤	53040030	8 422502 57079 9	0,9x5	6	108	



🟤 Marron / Braun / Brown / Brązowy
 🟡 Beige / Bambus / Bamboo / Bambus

🟢 Vert / Grün / Green / Zielony
 ⬛ Gris - Blanc / Grau - Weiß / Grey - White / Szary - Biały

🟤 Anthracite / Anthrazit / Anthracite / Antracyt



Brise-vue Balcony QUALITY 580 g/m²
Balkonbespannung QUALITY 580 g/m²
Balcony QUALITY Net 580 g/m²
Siatka Balcony QUALITY 580 g/m²



- FR** Brise-vue en fibre polyester recouverte de PVC. Oeillets de fixation en aluminium de 5,5 mm, situés tous les 33 cm. Inclut une corde de fixation de 4 mm par 12 m de longueur. Traitement anti-UV pour la protection de la couleur.
- DE** Sichtschutz aus PVC beschichteter Polyesterfaser. Befestigungsösen, hergestellt aus 5,5 mm Aluminium in 33 cm Abständen. Enthält eine 4 mm dicke und 12 m lange Kordel. Farbschutz durch anti-UV Behandlung.
- EN** Privacy mesh manufactured of PVC coated polyester fibre. 5.5 mm aluminum fixing eyelets every 33 cm. Includes 12 metres of 4 mm thick cord. Anti-UV treatment for colour protection.
- PL** Siatka maskująca wykonana z włókna poliestrowego powlekanego tworzywem PCV. Aluminiowe przelotki mocujące 5,5 mm rozmieszczone co 33 cm. Zawiera linkę o grubości 4 mm i długości 12 m. Z powłoką chroniącą przed promieniowaniem UV.



			m		
	53040010	8 422502 67502 9	0,9x3	6	180
	53040019	8 422502 97712 3	0,9x3	6	180



Brise-vue Balcony Rattan Luxe 830 g/m²
Balkonbespannung Rattan Luxe 830 g/m²
Balcony Rattan Luxe Net 830 g/m²
Siatka Balcony RATTAN LUXE 830 g/m²



- FR** Maille de balcon à occultation maximale grâce à sa composition en fibre de polyester recouvert de PVC. Œillets de fixation en aluminium de 10 mm. Option idéale pour les balcons et les terrasses.
- DE** Maximaler Schutz für Balkongitter dank seiner Zusammensetzung aus PVC-beschichteten Polyesterfasern. Befestigungsösen aus 10 mm Aluminium. Ideale Option für Balkone und Terrassen.
- EN** Maximum concealment balcony mesh thanks to its composition in pvc coated polyester fiber. Fixing eyelets made of 10 mm aluminum. Ideal option for balconies and terraces.
- PL** Siatka balkonowa, która ze względu na skład zapewnia maksymalny poziom maskowania. Wykonana z włókna poliestrowego powlekanego tworzywem PCV. Aluminiowe przelotki mocujące 10 mm. Idealnie nadaje się na balkony i tarasy.



			m		
	53040011	8 422502 37902 6	0,9x3	6	180
	53040012	8 422502 32388 3	0,9x3	6	180
	53030069	8 422502 60239 1	0,9x3	6	174



Gris - Noir / Grau - Schwarz / Grey - Black / Szary - Czarny
 Vert / Grün / Green / Zielony

Noir / Schwarz / Black / Czarny
 Marron / Braun / Brown / Brązowy

Argent / Silber / Silver / Silver

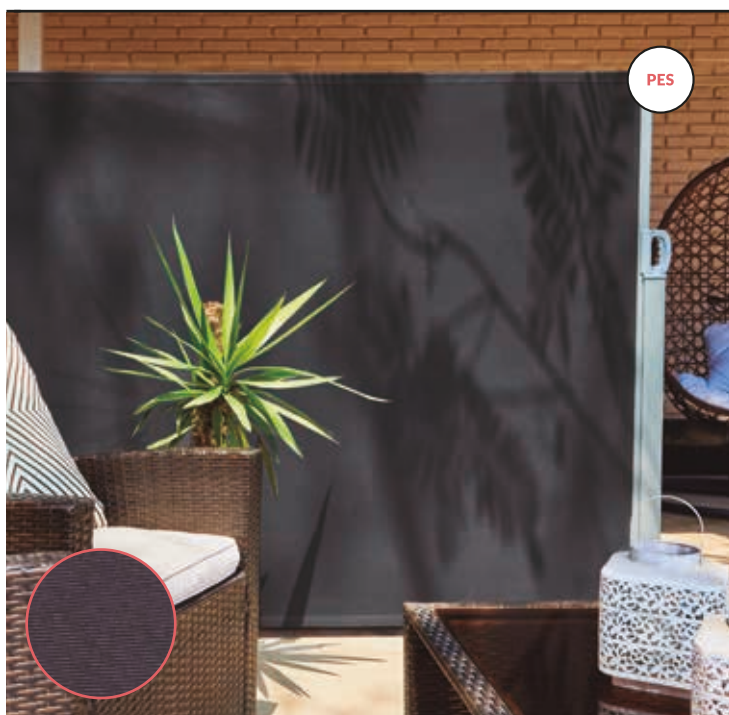

Séparateur d'ambiance extensible
Ausziehbarer Abteiler
Extensible room divider
Rozsuwana ściana działowa



- FR** Séparateur d'ambiance extensible en polyester+PU. Résistant à l'eau et aux UV. Idéal pour les terrasses et les jardins.
- DE** Ausziehbarer Abteiler aus Polyester und PU. Wasserabweisend, Ideal für Terrassen und Gärten
- EN** Extensible room divider made of Polyester and PU. Water resistant. Perfect for gardens and terraces.
- PL** Rozsuwana ściana działowa wykonana z poliestru i tworzywa PU. Wodoodporna, idealne nadaje się na taras lub do ogrodu.

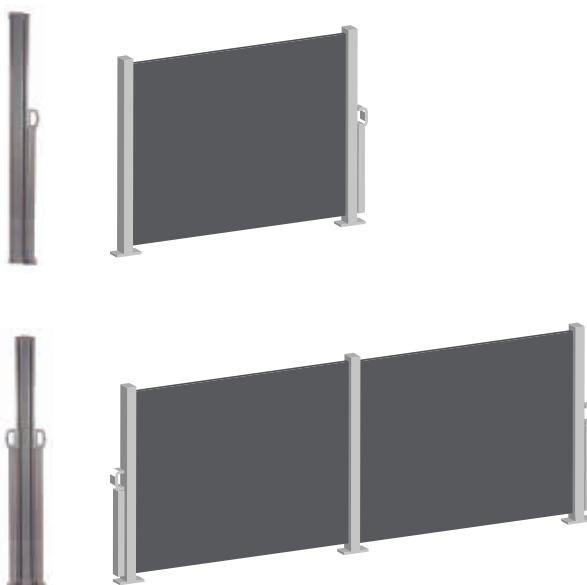

		m		
53040029	8 422502 61522 3	1,6x3	1	60
53040040	8422502 55840 7	1,6x3 (Double)	1	60



Clip de fixation | Befestigungsclip
Fixing clip | Klip mocujący



- FR** Complétez votre projet d'occultation avec des accessoires de fixation.
- DE** Vervollständigen Sie Ihr Abdeckmaschen Regal mit Befestigungszubehör.
- EN** Complete your privacy mesh shelf with fixing accessories.
- PL** Uzupełnij swoją linię siatek maskujących o elementy mocujące.



		cm		
22020009	8 422502 22566 8	4x5x1	20	1560



COOLMESH Voile d'ombrage réversible
COOLMESH Reversible shade mesh
COOLMESH Wendbarer Schattenspender
COOLMESH Odwracalna siatka cieniowana

PES

- FR** Grâce aux perforations dans son tissu, la natte d'ombrage COOLMESH filtre l'air et atténue les rayons de soleil ce qui favorise une ambiance fraîche et agréable.
- DE** Dank der Hohlräume in seinem Gewebe filtert das Beschattungsnetz COOLMESH die Luft und mildert die Sonneneinstrahlung und sorgt so für eine frische und angenehme Atmosphäre.
- EN** Thanks to the cavities in its fabric, the COOLMESH shading mesh filters the air and softens the sun's rays, providing a fresh and pleasant atmosphere.
- PL** Dzięki wnękom w tkaninie siatki COOLMESH filtruje powietrze i zmiękcza promienie słońca, zapewniając świeże i przyjemne środowisko.

GREY & WHITE
 BICOLOR
 GREY & WHITE



		m		
53170001	8 422502 49158 2	3x4	12	72

OCCULTATION | SICHTSCHUTZ | PRIVACY | MASKOWANIE



Moustiquaire | Insektenschutznetz Mosquito Screen | Moskitiera

- FR** Moustiquaire en fibre de verre, idéale pour vos fenêtres, facile à couper et très résistante.
- DE** Fiberglas-Gittergewebe ideal für die Platzierung in Fenstern. Leicht zu schneiden und sehr widerstandsfähig.
- EN** Fiberglass screen mesh ideal for placement in windows. Easy to cut and very resistant.
- PL** Siatka moskitiera siatki z włókna szklanego idealne do umieszczenia w oknach, łatwe do cięcia i bardzo odporne.

Fibre de verre | Glasfaser | Fibreglass | Włókno szklane

🔄	🏠		m	g/m ² ⚖️	📏	🚚
○	51010015	8 422502 85205 5	0,8x3	120	50	950
○	51010029	8 422502 85235 2	1x3	120	50	700
○	51010022	8 422502 85265 9	1,2x3	120	50	700
○	51010038	8 422502 85250 5	1x5	120	50	600
○	51010025	8 422502 85280 2	1,2x5	120	50	600
○	51010007	8 422502 55035 7	1x30	120	10	140
○	51010011	8 422502 55050 0	1,2x30	120	10	120
●	51010016	8 422502 85210 9	0,8x3	120	50	950
●	51010032	8 422502 85240 6	1x3	120	50	700
●	51010040	8 422502 85255 0	1x5	120	50	600
●	51010026	8 422502 85285 7	1,2x5	120	50	600
●	51010008	8 422502 55040 1	1x30	120	10	140
●	51010012	8 422502 55055 5	1,2x30	120	10	120



Grillage plastique carré | Viereckiges Kunststoffnetz | Square plastic Mesh Siatka z plastiku z kwadratowymi oczkami

300
g/m²

- FR** Ce grillage plastique élaboré avec les meilleures résines contient un traitement anti UV et contre l'humidité pour assurer une excellente durabilité.
- DE** Dieses Kunststoffnetz ist UV- und feuchtigkeitsgeschützt, was es zu einem sehr langlebigen Produkt macht.
- EN** This plastic mesh has UV protection and also protection against dampness to make it a very strong and durable product.
- PL** Ta plastikowa siatka posiada ochronę przed promieniowaniem UV i wilgocią, dzięki czemu jest bardzo mocnym i trwałym produktem.

🔄	🏠		m	cm 📏	📏	🚚
○	52010008	8 422502 850228	1x3	0,5	6	96
○	52010012	8 422502 850358	1x3	1	6	96
○	52010016	8 422502 850556	1x3	2	6	72
○	52010010	8 422502 850273	1x5	0,5	6	90
○	52010014	8 422502 850457	1x5	1	6	72
○	52010018	8 422502 850655	1x5	2	6	54
○	52010001	8 422502 400409	1x25	0,5	1	20
○	52010003	8 422502 400508	1x25	1	1	20
○	52010005	8 422502 400607	1x25	2	1	16
●	52010007	8 422502 850204	1x3	0,5	6	96
●	52010011	8 422502 850303	1x3	1	6	96
●	52010015	8 422502 850501	1x3	2	6	72
●	52010009	8 422502 850259	1x5	0,5	6	90
●	52010013	8 422502 850402	1x5	1	6	72
●	52010017	8 422502 850600	1x5	2	6	54
●	52010002	8 422502 400454	1x25	0,5	1	20
●	52010004	8 422502 400553	1x25	1	1	20
●	52010006	8 422502 400652	1x25	2	1	12



○ Blanc / Weiß / White / Biały
● Gris / Grau / Grey / Grey

● Vert / Grün / Green / Zielony



Grillage métallique plastifié | Viereckiges Kunststoffbeschichtetes metallgeflecht Plastic coated square Mesh | Plastyfikowana siatka metalowa z kwadratowymi oczkami

- FR** Recommandé pour vos plantations, pour la construction de clôture et pour la décoration et aménagement du jardin.
- DE** Für landwirtschaftliche Zwecke, Zaunkonstruktionen und dekorative Zwecke in Haus und Garten.
- EN** Suitable for agricultural use, for fencing and decorating house and garden.
- PL** Idealnie nadaje się do zastosowań rolniczych, konstrukcji ogrodzeniowych oraz jako dekoracja do ogrodu i domu.

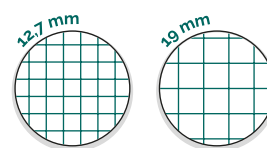

📦		m	mm	📏	🚚
55010015	8 422502 892808	0,5x3	12,7	9	216
55010016	8 422502 892907	0,5x3	19	9	216
55010019	8 422502 892853	1x3	12,7	9	144
55010020	8 422502 892952	1x3	19	9	144
55010018	8 422502 891054	0,5x5	12,7	9	144
55010022	8 422502 891108	1x5	12,7	9	81
55010014	8 422502 891009	0,5x10	12,7	9	72



Grillage métallique hexagonal plastifié Sechseckiges Kunststoffbeschichtetes Metallgeflecht | Plastic coated hexagonal Mesh Plastyfikowana siatka metalowa z sześciokątnymi oczkami

- FR** Recommandé pour vos plantations, pour la construction de clôture et pour la décoration et aménagement du jardin.
- DE** Geeignet für landwirtschaftliche Anwendungen, Zaunbau und dekorative Zwecke im Garten und zu Hause.
- EN** Suitable for agricultural applications, fence constructions and for decorative purposes in the garden and home.
- PL** Nadaje się do zastosowań rolniczych, ogrodzeń i form dekoracyjnych w ogrodzie i domu.

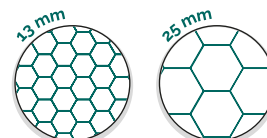

📦		m	mm	📏	🚚
55020009	8 422502 892303	0,5x3	13	9	315
55020010	8 422502 892402	0,5x3	25	9	432
55020019	8 422502 892358	1x3	13	9	225
55020020	8 422502 892457	1x3	25	9	324
55020007	8 422502 890507	0,5x10	13	9	135
55020008	8 422502 890552	0,5x10	25	9	135
55020013	8 422502 890606	1x10	25	9	144



Grillage carré galvanisé | Verzinktes Viereckgeflecht | Galvanised welded wire Mesh Siatka metalowa z kwadratowymi oczkami

- FR** Recommandé pour vos plantations, pour la construction de clôture et pour la décoration et aménagement du jardin.
- DE** Geeignet für landwirtschaftliche Anwendungen, Zaunbau und dekorative Zwecke im Garten und zu Hause.
- EN** Suitable for agricultural applications, fence constructions and for decorative purposes in the garden and home.
- PL** Idealnie nadaje się do zastosowań rolniczych, konstrukcji ogrodzeniowych oraz jako dekoracja do ogrodu i domu.

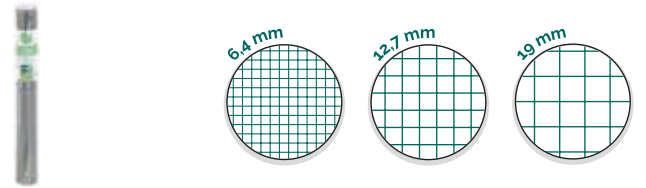

📦		m	mm◇	mm○	📏	🚚
55010003	8 422502 89260 0	0,5x3	12,7	1,05	9	216
55010004	8 422502 89270 9	0,5x3	19	1,05	9	216
55010005	8 422502 89250 1	0,5x3	6,4	0,6	9	216
55010008	8 422502 89265 5	1x3	12,7	1,05	9	144
55010009	8 422502 89275 4	1x3	19	1,05	9	144
55010010	8 422502 89255 6	1x3	6,4	0,6	9	225
55010012	8 422502 89090 3	1x5	12,7	1,05	9	81
55010007	8 422502 89085 9	0,5x5	12,7	1,05	9	135
55010002	8 422502 89080 4	0,5x10	12,7	0,8	9	72

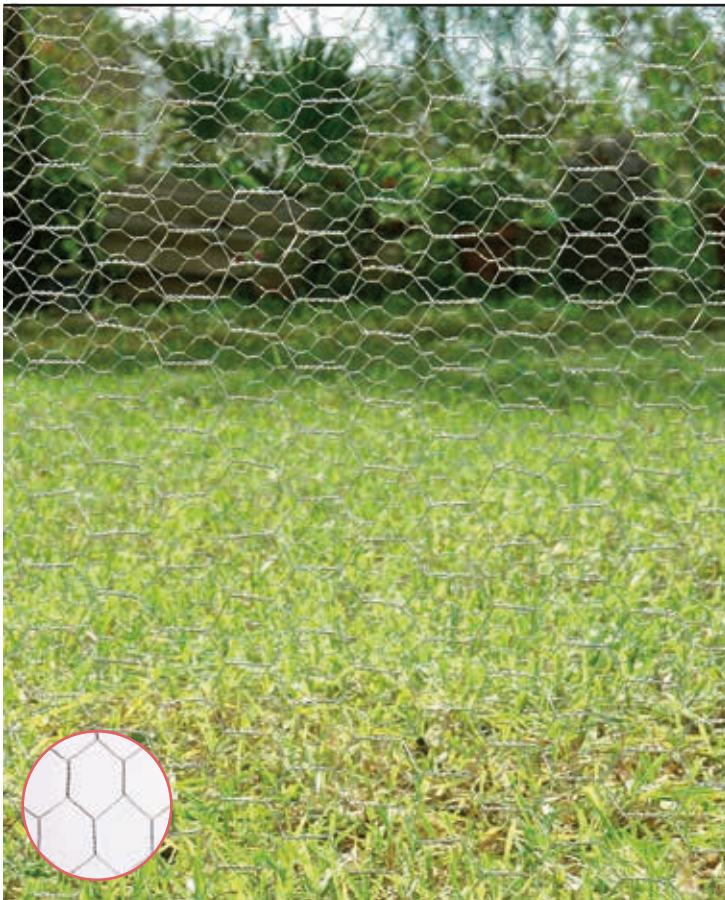

Grillage hexagonal galvanisé | Sechseckiges Metallgeflecht | Hexagonal wire Mesh Siatka metalowa z sześciokątnymi oczkami

- FR** Recommandé pour vos plantations, pour la construction de clôture et pour la décoration et aménagement du jardin.
- DE** Geeignet für landwirtschaftliche Anwendungen, Zaunbau und dekorative Zwecke im Garten und zu Hause.
- EN** Suitable for agricultural applications, fence constructions and for decorative purposes in the garden and home.
- PL** Idealnie nadaje się do zastosowań rolniczych, konstrukcji ogrodzeniowych oraz jako dekoracja do ogrodu i domu.

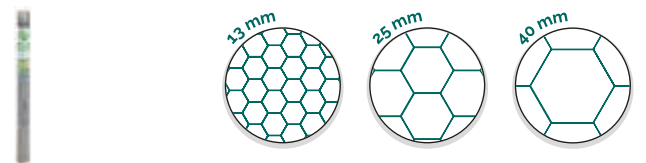

📦		m	mm◇	mm○	📏	🚚
55020003	8 422502 89200 6	0,5x3	13	0,7	9	315
55020004	8 422502 89210 5	0,5x3	25	0,8	9	432
55020011	8 422502 89220 4	0,5x3	40	0,9	9	432
55020016	8 422502 89205 1	1x3	13	0,7	9	324
55020017	8 422502 89215 0	1x3	25	0,8	9	180
55020018	8 422502 89225 9	1x3	40	0,9	9	324
55020001	8 422502 89010 1	0,5x10	13	0,7	9	135
55020002	8 422502 89015 6	0,5x10	25	0,8	9	216
55020014	8 422502 89020 0	1x10	40	0,9	9	225



Rouleau fil de fer plastifié
PVC-beschichteter Draht auf Rolle
Plastic coated garden wire Roll
Rolka plastyfikowanego drutu

📦		m	mm	📏	🚚
55030002	8 422502 89135 1	50	1,2	10	1740
55030004	8 422502 89125 2	50	2,7	20	840



Tendeur plastifié
Drahtspanner PVC-beschichtet
Plastic coated wire Strainer
Plastyfikowany napinacz

📦		📏	🚚
55030006	8 422502 89155 9	100	12000



Rouleau fil de fer galvanisé
Verzinkter Draht auf Rolle
Galvanised garden wire Roll
Rolka plastyfikowanego drutu metalowego

📦		m	mm	📏	🚚
55030001	8 422502 89130 6	50	1,1	50	2800
55030003	8 422502 89120 7	50	2	20	960



Tendeur galvanisé
Drahtspanner verzinkt
Galvanised wire Strainer
Napinacz z plastyfikowanego metalu

📦		📏	🚚
55030005	8 422502 89150 4	100	12000

Culture | Anbau
Culture | Uprawa





Culture

Nous vous proposons une large gamme de produits avec tout ce dont vous avez besoin pour faire pousser vos plantes.

Cultiver est devenu une activité de plus en plus présente tant dans les maisons avec des terrasses ou jardins que dans les appartements qui disposent d'un petit balcon.

Anbau

Damit bieten wir Ihnen eine breite Produktpalette an, damit Sie Ihre Pflanzen mit allem was Sie brauchen, anbauen können.

Kultivierung ist zu einer zunehmenden Aktivität geworden vorhanden in den Häusern. Nicht nur in großen Häusern mit großer Terrasse oder Garten, sondern auch in kleineren Wohnungen mit kleiner Terrasse.

Culture

We offer a wide range of products so you can grow your plants with everything you need.

Cultivating has become an activity more and more present in homes, both in those homes with large terraces or gardens and those that barely have a small balcony.

Uprawa

Oferujemy szeroką gamę niezbędnych produktów do uprawy roślin.

Coraz więcej gospodarstw domowych prowadzi własne uprawy na dużych tarasach i w ogrodach, a także na niewielkich balkonach.

Potagers urbains
Urban Gardens
Urban gardens
Miejskie ogrody warzywne 52

Paillage
Anti-Unkraut Netze
Anti-herb meshes
Siatki na chwasty i do odgradzania upraw 58

Protection des plantes
Pflanzenschutz
Crop protection
Ochrona upraw 59

Récolte
Sammlung
Organic waste collection
Zbieranie plonów 60

Croissance
Wachstum
Growth
Wzrost roślin 60





**Serre | Gewächshaus
Greenhouse | Szklarnia**



- FR** Serres composées d'une structure en acier, recouvertes d'une housse thermique transparente en PVC pour protéger les plantes du froid et du vent.
- DE** Gewächshaus aus Stahlstangen mit transparenter PVC-Hülle, das Pflanzen vor Kälte und Wind schützt.
- EN** Greenhouses consisting of a steel structure with a transparent PVC thermal cover to protect your plants from cold and wind.
- PL** Szklarnie o stalowej konstrukcji, pokryte przezroczystą osłoną termiczną z tworzywa PVC, która chroni rośliny przed zimnem i wiatrem.



GREENHOUSE

Icon	Barcode	cm	Icon	Icon
	71080016 8422502 79561 1	158x69x49		



GROUNDHOUSE

Icon	Barcode	cm	Icon	Icon
	71080017 8422502 08347 3	60x50x130		



**Serre SEED PLANTER 80
Urban garden SEED PLANTER 80
SEED PLANTER 80 Greenhouse
Szklarnia SEED PLANTER 80**



- FR** Le seed planter est une nouvelle manière d'organiser son petit potager urbain dans le jardin. Fabriqué en bois de pin sauvage, il est très facile à monter.
- DE** Die Seed Planters stellen eine neue Form dar, unseren kleinen Gemüse-Stadtgarten im Garten zu organisieren. Sie werden aus Waldkiefer hergestellt und sind sehr einfach zu montieren.
- EN** Seed planters are a new way of organising your small kitchen garden. They are manufactured in wild pine and are easy to assemble.
- PL** Sadzarki do nasion to nowy sposób na zorganizowanie małej plantacji warzyw w ogrodzie miejskim. Są bardzo łatwe w montażu, wykonane z drewna sosny zwyczajnej.



Contient un feutre non-tissé
Inklusive Unkrautvlies
Geotextile mesh included

Grand bac de culture
Effektive Saatfläche
Cultivation area
Powierzchnia uprawy

62x30x62 cm

Icon	Barcode	cm	Icon	Icon
	31090014 8422502719303	80x30x80		

CULTURE | ANBAU | CULTURE | UPRAWA



Serre SEED PLANTER 100
Urban garden SEED PLANTER 100
SEED PLANTER 100 Greenhouse
Szklarnia SEED PLANTER 100



FR Le potager urbain SEED PLANTER 100 qui mesure 22x100x100 cm (hauteur x largeur x longueur), est conçu pour être installé sur votre terrasse ou dans votre jardin. Son montage est très simple. Le potager comprend un feutre géotextile sur lequel placer le substrat.

DE Der Stadtgarten SEED PLANTER 100 - hat folgende Abmessungen; 22x100x100 cm (Höhe x Breite x Länge). Sehr geeignet für Ihre Terrasse oder in Ihrem Garten zu montieren, die Montage ist sehr einfach. Darüber hinaus enthält der Anbaugarten ein Geotextilgewebe, das Es fungiert als Basis und auf die das Substrat gelegt wird.

EN The size of the SEED PLANTER 100 is 22x100x100 cm (height x width x length). It is designed to be installed on your terrace or garden and is very simple to assemble. In addition, the garden for cultivation includes a geotextile mesh that will act as a base on which the substrate will be placed.

PL Bardzo prosty w montażu miejski ogród SEED PLANTER 100 o wymiarach 22x100x100 cm (wys. x szer. x dł.), który można umieścić na tarasie lub w ogrodzie. Dodatkowo ma w zestawie siatkę z geowłókniny, która służy jako baza do podłoża.



info
 Contient un feutre non-tissé
 Inklusive Unkrautvlies
 Geotextile mesh included
 Grand bac de culture
 Effektive Saatfläche
 Cultivation area
 Powierzchnia uprawy

79x22x79 cm

		cm		
75010001	8 422502 13845 6	100x22x100	1	20



Serre SEED PLANTER 120
Urban garden SEED PLANTER 120
SEED PLANTER 120 Greenhouse
Szklarnia SEED PLANTER 120



FR Le potager urbain SEED PLANTER 120 de Catral Garden est un carré potager de grandes dimensions conçu pour que cela devienne une activité simple et amusante. Il est divisé en 9 compartiments, vous pouvez donc cultiver tout ce que vous voulez confortablement et individuellement.

DE Der Stadtgarten SEED PLANTER 120 von Catral Garden ist eine Große, wachsende Kommode für den Anbau. Der design macht Anbauen zu einer unterhaltsamen Aktivität. Es ist in 9 Fächern unterteilt, damit Sie bequem Pflanzen können.

EN The SEED PLANTER 120 is a large-scale box designed to make farming a simple and fun activity. It is divided into 9 compartments, so you can cultivate comfortably and individually all the plants you want.

PL Miejski ogród SEED PLANTER 120 marki Catral Garden to duża skrzynia zaprojektowana tak, aby ułatwić i uprzyjemnić uprawę roślin. Jest podzielony na 9 przegródek, które umożliwiają osobną i wygodną uprawę wszystkiego, co zechcesz.



info
 Contient un feutre non-tissé
 Inklusive Unkrautvlies
 Geotextile mesh included
 Grand bac de culture
 Effektive Saatfläche
 Cultivation area
 Powierzchnia uprawy

102x40x102 cm

		cm		
31090013	8 422502 92858 3	120x40x120	1	16



Serre TABLE PLANTER GERMIN 40
Urban garden TABLE PLANTER GERMIN 40
TABLE PLANTER GERMIN 40 Greenhouse
Szklarnia TABLE PLANTER GERMIN 40



- FR** Fabriqué en pin, le potager GERMIN 40 permet de jardiner sans se baisser grâce à sa hauteur de 88cm. Avec son bac de 25cm de profondeur il offre une capacité de 81 litres.
- DE** Der aus Kiefernholz gefertigte Gemüsegarten GERMIN 40 hat die Maße 88x76x48 cm (Breite x Höhe x Länge), eine Behälterhöhe von 25 cm und ein Gesamtvolumen von 81 Litern.
- EN** TABLE PLANTER GERMIN 40 is manufactured in pine wood and it measures 88x76x48 cm (width x height x length). Its height is 25 cm and its total capacity is 81 litres.
- PL** Wykonany z drewna sosnowego, warzywnik GERMIN 40 ma wymiary 88x76x48 cm (szerokość x wysokość x długość), wysokość 25 cm i pojemność całkowitą 81 litrów.

info

Éléments pré-perçés pour faciliter le montage
 Löcher vorgebohrt für einfachste Montage
 Pre-drill included
 Wywiercone otwory



Contient un feutre non-tissé
 Inklusive Unkrautvlies
 Geotextile mesh included

Grand bac de culture
 Effektive Saatfläche
 Cultivation area
 Powierzchnia uprawy

80x21x40 cm



🏠	📏	cm	📦	🚚
75020001	8 42250268604 9	88x76x48	1	9



Serre TABLE PLANTER GERMIN 60
Urban garden TABLE PLANTER GERMIN 60
TABLE PLANTER GERMIN 60 Greenhouse
Szklarnia TABLE PLANTER GERMIN 60



- FR** Fabriqué en pin, sa division en 6 compartiments permet une séparation aisée et esthétique entre différentes plantations. Sa hauteur permet de ne pas avoir à se baisser. 80x80x60 (hauteur x Longueur x largeur).
- DE** Hergestellt aus Kiefernholz. Entworfen mit 6 separaten Behältern, so dass Sie verschiedene Arten von Pflanzen bequem anbauen können. Abmessungen 80x80x60 cm (Breite x Höhe x Länge).
- EN** TABLE PLANTER GERMIN 60 is made of pine wood and it is designed with 6 separate compartments, so you can grow different types of plants in a comfortable way. It measures 80x80x60 cm (width x height x length).
- PL** Fabricado en madera de pino, está diseñado con 6 compartimentos separados, para que puedas cultivar diferentes tipos de plantas de una forma cómoda. Cuenta con unas medidas de 80x80x60 cm (ancho x alto x largo).

info

Contient un feutre non-tissé
 Inklusive Unkrautvlies
 Geotextile mesh included

Grand bac de culture
 Effektive Saatfläche
 Cultivation area
 Powierzchnia uprawy

76x23x50 cm



🏠	📏	cm	📦	🚚
31090015	8 42250282976 7	80x80x60	1	10



Table de jardin KITCHENBOX
Hochbeet KITCHENBOX
KITCHENBOX Garden table
Stół uprawny KITCHENBOX



- FR** Kitchenbox permet de profiter du jardin tout en apprenant à s'occuper de ses plantes et de ses cultures.
- DE** Die Kitchenbox wurde für diejenigen entworfen, die gerne Ihre Zeit im Garten geniessen und mit dem eigenen Anbau beginnen möchten.
- EN** Kitchenbox has been designed for everyone to enjoy the garden naturally learning to grow plants and crops.
- PL** Kitchenbox jest zaprojektowany tak, abyśmy mogli nauczyć się dbać o nasze rośliny i cieszyć się naszą uprawą.



info
 Contient un feutre non-tissé 60 g/m²
 Inklusive Unkrautvlies 60 g/m²
 Geotextile mesh included 60 g/m²
 Grand bac de culture
 Effektive Saatfläche
 Cultivation area
 Powierzchnia uprawy

36x15x46 cm

		cm		
75020004	8 42250235042 1	40x45x50	1	12



Étagère jardin SCALENATURE
Gartenregal SCALENATURE
SCALENATURE Garden rack
Półka ogrodowa SCALENATURE



- FR** Fabriqué en pin, l'étagère SCALENATURE comporte 3 étagères pour donner du relief à votre décoration.
- DE** Hergestellt aus Kiefernholz. Das Regal SCALENATURE hat 3 Ebenen und die Maße 42x100x44 (Breite x Höhe x Länge).
- EN** SCALENATURE is made of pine wood and the shelf has 3 levels. It measures 42x100x44 cm (width x height x length).
- PL** Wykonana z drewna sosnowego półka SCALENATURE ma 3 poziomy i wymiary 42x100x44 cm (szerokość x wysokość x długość).



		cm		
75010006	8 42250212574 6	42x100x44	1	12



LINENATURE 3 compartiments
LINENATURE Blumenkasten mit
3 Fächern | LINENATURE 3 cavities
LINENATURE Ogród warzywny 3-komorowy



- FR** Fabriqué en pin, le potager Linenature comprend 3 divisions pour séparer aisément différentes plantations.
- DE** Hergestellt aus Kiefernholz. Der LINENATURE-Gemüsegarten hat 3 Hohlräume und die Maße 140x60x40 cm (Breite x Höhe x Länge).
- EN** LINENATURE is made of pine wood. It has 3 cavities and measures 140x60x40 cm (width x height x length).
- PL** Wykonany z drewna sosnowego ogródek warzywny LINENATURE ma 3 wnęki i wymiary 140x60x40 cm (szerokość x wysokość x długość).



Contient un feutre non-tissé 60 g/m²
Inklusive Unkrautvlies 60 g/m²
Geotextile mesh included 60 g/m²
Grand bac de culture
Effektive Saatfläche
Cultivation area
Powierzchnia uprawy

120x39x38,5 cm

info

		cm		
75010007	8 422502 93266 5	140x60x40	1	12



STEPNATURE 3 compartiments
STEPNATURE Treppenförmiger
Pflanzkasten | STEPNATURE 3 cavities
STEPNATURE Schodkowy ogród warzywny
3-komorowy Scale



- FR** Fabriqué en pin, le potager STEPNATURE dispose de 3 bacs à des hauteurs différentes pour créer un effet cascade.
- DE** Hergestellt aus Kiefernholz. Der STEPNATURE Gemüsegarten hat 3 Stufen und Behälter und misst 113x40x88cm (Breite x Höhe x Länge).
- EN** STEPNATURE is made of pine wood. It has 3 cavities and measures 113x40x88 cm (width x height x length).
- PL** Fabricado en madera de pino, el huerto STEPNATURE tiene 3 niveles y recipientes, y cuenta con unas medidas de 113x40x88 cm (ancho x alto x largo).



Contient un feutre non-tissé 60 g/m²
Inklusive Unkrautvlies 60 g/m²
Geotextile mesh included 60 g/m²
Grand bac de culture
Effektive Saatfläche
Cultivation area
Powierzchnia uprawy

Nivel 1> 100x20x24,5 cm
 Nivel 2> 100x30x24,5 cm
 Nivel 3> 100x40x24,5 cm

info

		cm		
75010008	8 422502 32904 5	113x40x88	1	12



Balais | Besen | Brooms | Miotty

- FR** Balais artisanaux fabriqués avec des matériaux naturels.
- DE** Manuell hergestellte Besen aus natürlichen Materialien.
- EN** Handcrafted brooms made of natural materials.
- PL** Ręcznie robione miotty wykonane z naturalnych materiałów.

 Notre premier produit depuis 1928
 Unser Allererstes Produkt von 1928
 Our first product since 1928
 Nasz pierwszy produkt od 1928 roku



			 		
1	71020001	8 422502 420025	Mijo/Madera	6	600
2	71020003	8 422502 050017	Palma/Caña	12	600
3	71020004	8 422502 050024	Palma/Madera	12	600





Table de travail GREEN TABLE Arbeitstisch GREEN TABLE Work table GREEN TABLE Stół roboczy GREEN TABLE

- FR** Table conçue pour avoir à portée de main tous les outils afin de pouvoir travailler confortablement. L'étagère supérieure est en bois recouvert de zinc.
- DE** Gartenarbeitstisch für ein bequemes Arbeiten mit vielen Ablageflächen für Werkzeuge und sonstiges zubehör. Arbeitsfläche verzinkt.
- EN** Garden working table for comfortable working with many storage areas for tools and other accessories. Working surface galvanized.
- PL** Stół zaprojektowany tak, aby mieć wszystkie narzędzia pod ręką i móc wygodnie pracować. Górna półka jest wykonana z ocynkowanego drewna.



 **Éléments pré-perçés pour faciliter le montage**
Löcher vorgebohrt für einfachste Montage
 Pre-drill included
 Wywiercone otwory

			cm		
75060001	8 42250257528 2	113x84x40		1	10



Toile de paillage | Unkrautvlies
Weed barrier | Siatka na chwasty



- FR** Toile de paillage en polypropylène à utiliser pour couvrir les sols de serres, les plantations et les jardins contre les mauvaises herbes.
- DE** Netzgewebe aus Polypropylen, gegen Unkraut als Bodenbelag von Gewächshäusern, Plantagen und Gärten geeignet.
- EN** Polypropylene mesh for use as anti-weed flooring in greenhouses, plantations and gardens.
- PL** Siatki polipropylenowe służą do pokrycia podłóg szklarni, plantacji i ogrodów w celu ochrony przed chwastami.

	54010033	8 422502 26058 4	1x10	105	12	240 NEW!
	54010023	8 422502 85500 1	1x10	105	12	240
	54010025	8 422502 85516 2	1x25	105	8	80
	54010001	8 422502 45090 9	1x100	105	1	25
	54010003	8 422502 45095 4	1,5x100	105	1	25
	54010005	8 422502 45100 5	2x100	105	1	25
	54010007	8 422502 45105 0	3x100	105	1	20
	54010009	8 422502 45110 4	4x100	105	1	16
	54010011	8 422502 45117 3	1x100	130	1	25
	54010013	8 422502 45119 7	1,5x100	130	1	25
	54010015	8 422502 45120 3	2x100	130	1	25
	54010017	8 422502 45125 8	3x100	130	1	9
	54010019	8 422502 45130 2	4x100	130	1	9
	54010024	8 422502 85526 1	1x10	105	12	240
	54010026	8 422502 85528 5	1x25	105	8	80
	54010002	8 422502 45150 0	1x100	105	1	25
	54010004	8 422502 45152 4	1,5x100	105	1	25
	54010006	8 422502 45154 8	2x100	105	1	25
	54010008	8 422502 45156 2	3x100	105	1	16
	54010010	8 422502 45158 6	4x100	105	1	16
	54010012	8 422502 45162 3	1x100	130	1	25
	54010014	8 422502 45164 7	1,5x100	130	1	25
	54010016	8 422502 45166 1	2x100	130	1	25
	54010018	8 422502 45168 5	3x100	130	1	9
	54010020	8 422502 45170 8	4x100	130	1	9



Feutre de paillage STOP-GRASS
Unkrautvlies STOP-GRASS
Anti-weed mesh STOP-GRASS
Siatka do zwalczania chwastów STOP-GRASS



- FR** Feutre de paillage qui évite la pousse de l'herbe, perméable à l'eau et à l'air, il permet également de séparer des couches de terre et de cailloux.
- DE** PP-Unkrautvlies, verhindert das Wachstum von Unkraut, ist wasserdurchlässig und trennt Boden- und Steinschichten.
- EN** PP weed control felt that prevents weed growth, water permeable, separates soil and stone layers.
- PL** PP filc przeciw chwastom zapobiegający wzrostowi chwastów, przepuszczający wodę, oddzielający warstwy gleby i kamienia.



	04010001	8 422502 55426 3	1,25x25	10 60





Feutre géotextile
Geotextil Unkrautvlies
Geotextil anti-weed mesh
Siatka z geowłókniny

PP

- FR** Feutre géotextile pour couvrir les sols de serres, de potagers ou d'allées. Évite la pousse des mauvaises herbes.
- DE** Polypropylengewebe für Gewächshausbodenbeläge, Plantagen und Gärten gegen Unkraut.
- EN** Polypropylene mesh for covering floors of greenhouses, plantations and gardens against weeds.
- PL** Siatki polipropylenowe służą do pokrycia podłóg szklarni, plantacji i ogrodów w celu ochrony przed chwastami.



🔄	🏠	📏	m	g/m ²	📦	🚚
54010021	8 422502 85629 9	1,5x10	80	1	200	
54010022	8 422502 85630 5	1,5x10	80	1	200	

PROTECTION DES PLANTES | PFLANZENSCHUTZ | CROP PROTECTION | OCHRONA UPRAW



Filet anti-oiseaux BIRDY-MESH
Vogelschutzgewebe BIRDY-MESH
BIRDY-MESH
Siatki przeciw ptakom BIRDY-MESH

PE

- FR** Filet anti-oiseaux de maille 18mm en PE, Traité anti-UV, résistant et léger. Idéal pour protéger vos récoltes des oiseaux.
- DE** PE - Vogelabwehrnetz, Lochweite 18mm viereckig, zur Abwehr von Vögeln.
- EN** A tough, light rhomboid PE mesh of 18 mm square. Recommended for agricultural use, particularly for safeguarding crops and protecting fields from bird damage.
- PL** Kwadratowa siatka z oczkami o szerokości 18 mm i gramaturze 10 g/m², wykonana z odpornego i lekkiego tworzywa PE. Wskazana do zastosowań rolniczych, w szczególności do odstraszenia ptaków, które niszczą i ograniczają plony sadów i upraw.

🔄	🏠	📏	m	g/m ²	mm	📦	🚚
01010002	8 422502 66327 9	2x10	17	17	12	360	



Blanc / Weiß / White / Biały
 Gris / Grau / Grey / Grey

Vert / Grün / Green / Zielony



FARMBOX Composteur | FARMBOX Komposter FARMBOX Compost | Kompostownik FARMBOX

- FR** Composteur complet en bois. Idéal pour réaliser un compostage domestique de vos déchets. Il dispose d'une ouverture à la base pour faciliter la collecte du compost.
- DE** Holzkompost. Ideal für die Herstellung von Bio-Kompost. Der Komposter verfügt über eine erweiterte Basis für die Kompostsammlung
- EN** Wood compost . Ideal to make organic compost . The furniture has an extended base to make easy the process to pick the organic compost.
- PL** Kompletny drewniany kompostownik. Idealna opcja, by prowadzić proces kompostowania w domu. Przegroda w podstawie ułatwia zbieranie kompostu.



🏠	📏	cm	📦	🚚
31100010	8 422502798728	60x65x90	1	25

CROISSANCE | WACHSTUM | GROWTH | WZROST ROŚLIN



Tuteurs de bambou | Bambus-Stangen Bamboo Stakes | Pale bambusowe

- FR** Tuteurs de bambous de différentes dimensions spécialement adaptés pour tutorer vos plantes qu'elles soient décoratives ou potagères.
- DE** Bambusstangen in verschiedenen Größen, insbesondere für den Anbau verwendet. Sie werden zur Förderung des Pflanzenwachstums und zur Stützung verschiedener Maschen, wie z. B. Stangen, eingesetzt.
- EN** Bamboo stakes available in different sizes, especially for use in cultivation. They are used to help plants grow and to support different meshes as posts.
- PL** Paliki bambusowe są dostępne w różnych rozmiarach, szczególnie do stosowania w uprawie. Służą one do podtrzymywania wzrostu roślin oraz do podtrzymywania różnych siatek jako słupków.

🏠	📏	cm	mm ø	📦	🚚
91010013	8 422502 060016	60	6-8	1000	30000
61010006	8 422502 060023	90	8-10	500	12500
61010001	8 422502 060184	105	8-10	500	18000
61010007	8 422502 060030	120	10-12	500	10000
61010008	8 422502 060047	150	12-14	250	6250
61010009	8 422502 060054	180	14-16	250	4000
61010010	8 422502 060078	210	16-18	100	3600
61010012	8 422502 663576	244	16-18	100	3600
61010003	8 422502 060085	250	18-20	100	3600
61010004	8 422502 060092	305	20-22	100	2500
61010005	8 422502 060108	305	30-35	25	1225

Netting non inclus | Netting nicht enthalten | Mesh not included | Nie zawiera siatki

Aménagement extérieur | Aussenausstattung
Outdoor fitting | Wyposażenie zewnętrzne





Gazon artificiel

La gamme de gazon X-tra est la réponse de notre département de Recherche et Développement aux besoins du marché, pour obtenir les meilleurs produits en composition, capacité de drainage, et esthétique.

Nouveau support

- Meilleur drainage
- Moins de rétraction
- Coutures plus résistantes

Kunstrasen

Der Kunstrasen X-tra ist die Antwort unseres Innovationsteams auf die Marktbedürfnisse, Ziel war es den hochwertigsten Kunstrasen zu entwickeln. Dank seiner Zusammensetzung verfügt er über eine hervorragende Entwässerungskapazität sowie über ein exzellentes Design.

Neue Oberfläche der Auflage

- Perfekte drainage
- Kein Zusammenziehen
- Haltbare Naht

Artificial grass

The X-tra grass Range is the answer from our innovation team to the market needs. Thanks to its composition, high drainage capacity and design.

New backing

- Best drainage
- Less shrinkage
- More resistant stitches

Imitacja trawnika

Gama trawników X-TRA to odpowiedź naszego zespołu ds. rozwoju innowacji na potrzeby rynku. Rezultatem jest najlepszy trawnik ze względu na jego skład, wzornictwo i wysoką zdolność drenażową.

Nasza linia sztucznych trawników dostosowuje się do potrzeb wszystkich naszych klientów.

Nowe podłoże

- Lepszy drenaż
- Mniejsza kurczliwość
- Mocniejsze przeszycia

Gazon artificiel
Kunstrasen
Artificial grass
Imitacja trawnika

64

Accessoires
Zubehör
Accessories
Akcesoria

71





Gazon artificiel NEW PIAZZA X-TRA S30/ S40
Kunstrasen NEW PIAZZA X-TRA S30/ S40
Artificial grass NEW PIAZZA X-TRA S30/ S40
Imitacja trawnika NEW PIAZZA X-TRA S30/ S40

- FR** Gazon de dernière génération, d'aspect très naturel, de grande résistance, douceur et d'un excellent effet mémoire qui le différencie des autres modèles du marché.
- DE** Kunstrasen der neuesten Generation, mit einem sehr natürlichen Aussehen, die Halme werden sehr dicht genäht, sehr weich, sanft und einen ausgezeichneten „Memory-Effekt“ das unterscheidet unser Kunstrasen von den anderen Marktmodellen.
- EN** State-of-the-art turf, with a very natural appearance, high level of greenery, softness and an excellent memory effect that differentiates it from other models on the market.
- PL** Trawnik najnowszej generacji o naturalnym wyglądzie. Sprśród innych modeli na rynku wyróżnia się największą bujnością, miękkością i odpornością na deptanie.

📦		↕	m	↕mm	📦	🚚
22050031	8422502 588527	S30	2X4	30	1	15
22050032	8422502 716425	S30	2X10	30	1	6
22050033	8422502 176007	S30	2X20	30	1	8
22060014	8422502 517718	S40	2X4	40	1	12
22060015	8422502 879519	S40	2X10	40	1	4
22060016	8422502 19408 7	S40	2X20	40	1	4



NEW PIAZZA S30

N° points Anzahl der Stiche No. Stitches Liczba ściegów:	25.200/m ²
Drainage Wasserablauf Drainage Odwodnienie:	50 l/ m ²
Poids Gewicht Weight Waga:	2.590 g/ m ²



NEW PIAZZA S40

N° points Anzahl der Stiche No. Stitches Liczba ściegów:	25.200/m ²
Drainage Wasserablauf Drainage Odwodnienie:	50 l/ m ²
Poids Gewicht Weight Waga:	3.000 g/ m ²



Autres caractéristiques | Andere Merkmale | Other features | Inne cechy

Résistance Widerstand Resistance Odporność	████████████████████
Nettoyage Reinigung Cleaning Czyszczenie	████████████████████
Reprend sa forme après le piétinement Keine Trittspuren Tread recovery Odzyskanie śladu stopy	████████████████████
Douceur Weich Softness Gładkość	████████████████████
Aspect naturel Natürliches aussehen Natural look Naturalny wygląd	████████████████████





Gazon artificiel DENIA X-TRA S30/ S40
Kunstrasen DENIA X-TRA S30/ S40
Artificial grass DENIA X-TRA S30/ S40
Imitacja trawnika DENIA X-TRA S30/ S40

- FR** Gazon haut de gamme, fait de fibres de dernière génération lui donnant un aspect très naturel, très luxuriant et avec un excellent effet mémoire.
- DE** Ein Kunstrasen hergestellt aus Kunstfasern der neuesten Generation. Dadurch erhält der Rasen ein üppiges Aussehen und die Halme stellen sich in kürzester Zeit wieder auf.
- EN** Artificial grass made of the latest generation of artificial fibers. This gives the grass a lush appearance and the stalks reappear in a very short time.
- PL** Trawnik najwyższej jakości o dużej odporności na deptanie. Wykonany z włókien ostatniej generacji, które zapewniają bujność i bardzo naturalny wygląd.

📦		±Δ	m	±1mm	🚚	🚚
22040006	8422502 388653	S20	2x4	20	1	15
22040007	8422502 398478	S20	2x10	20	1	9
22040008	8422502 567331	S20	2x20	20	1	4
22050016	8422502 353415	S30	2x4	30	1	12
22050017	8422502 124220	S30	2x10	30	1	9
22050018	8422502 537402	S30	2x20	30	1	4
22060007	8422502 886890	S40	2x4	40	1	8
22060008	8422502 731428	S40	2x10	40	1	6
22060009	8422502 326877	S40	2x20	40	1	4
22070002	8422502 567003	S50	2x4	50	1	6
22070003	8422502 218455	S50	2x10	50	1	4
22070004	8422502 768721	S50	2x20	50	1	4

DENIA S20

N° points | Anzahl der Stiche | No. Stitches | Liczba ściegów: 15.750/ m²
 Drainage | Wasserablauf | Drainage | Odwodnienie: 60 l/ m²
 Poids | Gewicht | Weight | Waga: 2.400 g/ m²

DENIA S30

N° points | Anzahl der Stiche | No. Stitches | Liczba ściegów: 15.750/ m²
 Drainage | Wasserablauf | Drainage | Odwodnienie: 60 l/ m²
 Poids | Gewicht | Weight | Waga: 2.800 g/ m²

DENIA S40

N° points | Anzahl der Stiche | No. Stitches | Liczba ściegów: 15.750/ m²
 Drainage | Wasserablauf | Drainage | Odwodnienie: 60 l/ m²
 Poids | Gewicht | Weight | Waga: 3.200 g/ m²

DENIA S50

N° points | Anzahl der Stiche | No. Stitches | Liczba ściegów: 15.750/ m²
 Drainage | Wasserablauf | Drainage | Odwodnienie: 60 l/ m²
 Poids | Gewicht | Weight | Waga: 3.700 g/ m²

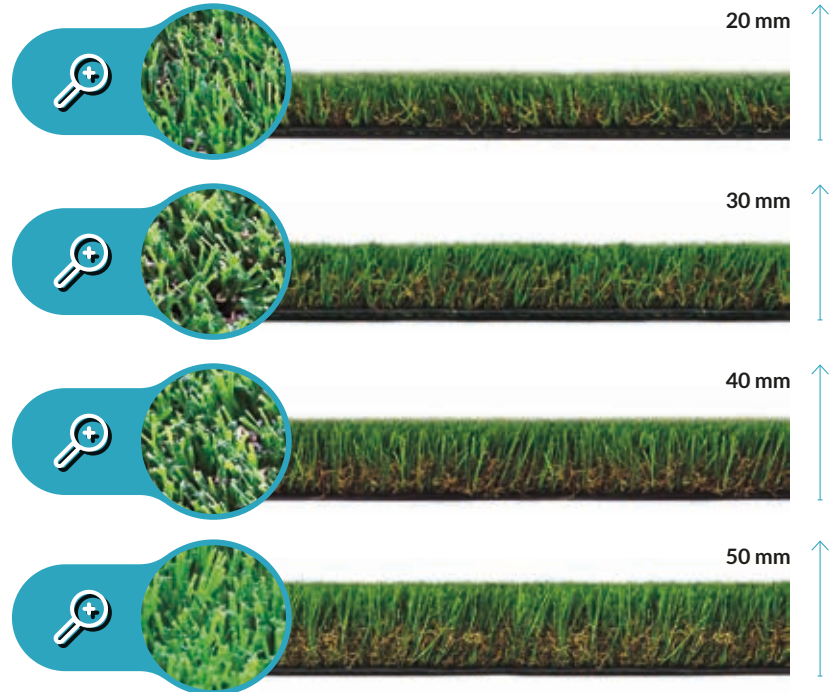

Autres caractéristiques | Andere Merkmale | Other features | Inne cechy

- Résistance | Widerstand | Resistance | Odporność
- Nettoyage | Reinigung | Cleaning | Czyszczenie
- Reprend sa forme après le piétinement | Keine Trittspuren | Tread recovery | Odzyskanie śladu stopy
- Douceur | Weich | Softness | Gładkość
- Aspect naturel | Natürliches aussehen | Natural look | Naturalny wygląd





Gazon artificiel AITANA X-TRA S30/ S40
Kunstrasen AITANA X-TRA S30/ S40
Artificial grass AITANA X-TRA S30/ S40
Imitacja trawnika AITANA X-TRA S30/ S40

- FR** Gazon haut de gamme, élaboré avec des fibres de dernière génération lui conférant un aspect très naturel et un excellent effet mémoire.
- DE** Ein Kunstrasen der höheren Preisklasse, hergestellt aus modernsten Kunstfasern, die ihm einen sehr natürliches Aussehen und einen ausgezeichneten "Memory-Effekt" verleihen.
- EN** This is top of the range grass manufactured with state-of-the-art fibres that give an extremely natural appearance and excellent spring back abilities.
- PL** Trawnik najwyższej jakości o dużej odporności na deptanie. Wykonany z włókien ostatniej generacji, które zapewniają bardzo naturalny wygląd.

📦		±Δ	m	±mm	📄	🚚
22050028	8422502 778492	S30	2x4	28	1	30
22050029	8422502 591466	S30	2x10	28	1	16
22050030	8422502 066735	S30	2x20	28	1	4
22060011	8422502 313747	S40	2x4	42	1	16
22060012	8422502 204106	S40	2x10	42	1	9
22060013	8422502 344208	S40	2x20	42	1	4

AITANA S30

N° points | Anzahl der Stiche | No. Stitches | Liczba ściegów: 17.850/ m²

Drainage | Wasserablauf | Drainage | Odwodnienie: 60 l/ m²

Poids | Gewicht | Weight | Waga: 2.600 g/ m²



AITANA S40

N° points | Anzahl der Stiche | No. Stitches | Liczba ściegów: 17.850/ m²

Drainage | Wasserablauf | Drainage | Odwodnienie: 60 l/ m²

Poids | Gewicht | Weight | Waga: 3.750 g/ m²



Autres caractéristiques | Andere Merkmale | Other features | Inne cechy

Résistance | Widerstand | Resistance | Odporność

Nettoyage | Reinigung | Cleaning | Czyszczenie

Reprend sa forme après le piétinement | Keine Trittsuren
Tread recovery | Odzyskanie śladu stopy

Douceur | Weich | Softness | Gładkość

Aspect naturel | Natürliches aussehen | Natural look | Naturalny wygląd





Gazon artificiel GUADALEST X-TRA S20/ S30
Kunstrasen GUADALEST X-TRA S20/ S30
Artificial grass GUADALEST X-TRA S20/ S30
Imitacja trawnika GUADALEST X-TRA S20/ S30

- FR** Gazon artificiel avec un aspect très naturel qui apporte une excellente relation Qualité/prix.
- DE** Ein Kunstrasen mit natürlichem Aussehen, der zu einem ausgezeichneten Preis-Leistungsverhältnis bietet.
- EN** Artificial grass with a natural look, providing quality and an excellent price/quality ratio.
- PL** Sztuczna trawa o naturalnym wyglądzie, zapewniająca jakość i doskonały stosunek jakości do ceny.

📦		±Δ	m	±mm	📦	🚚	
22040014	8422502 207343	S20	2x4	22	1	-	NEW!
22040015	8422502 758098	S20	2x10	22	1	-	NEW!
22040016	8422502 402854	S20	2x20	22	1	-	NEW!
22050034	8422502 142491	S30	2x4	32	1	-	NEW!
22050035	8422502 123810	S30	2x10	32	1	-	NEW!
22050036	8422502 789740	S30	2x20	32	1	-	NEW!

GUADALEST S20

N° points | Anzahl der Stiche | No. Stitches | Liczba ściegów: 21.000/ m²

Drainage | Wasserablauf | Drainage | Odwodnienie: 60 l/ m²

Poids | Gewicht | Weight | Waga: 1.580 g/ m²



GUADALEST S30

N° points | Anzahl der Stiche | No. Stitches | Liczba ściegów: 25.200/ m²

Drainage | Wasserablauf | Drainage | Odwodnienie: 60 l/ m²

Poids | Gewicht | Weight | Waga: 1.930 g/ m²



Autres caractéristiques | Andere Merkmale | Other features | Inne cechy

Résistance Widerstand Resistance Odporność	<div style="width: 90%;"></div>
Nettoyage Reinigung Cleaning Czyszczenie	<div style="width: 80%;"></div>
Reprend sa forme après le piétinement Keine Trittspuren Tread recovery Odzyskanie śladu stopy	<div style="width: 70%;"></div>
Douceur Weich Softness Gładkość	<div style="width: 85%;"></div>
Aspect naturel Natürliches aussehen Natural look Naturalny wygląd	<div style="width: 95%;"></div>

WARRANTY 5

PET FRIENDLY

RECOVERY

AMÉNAGEMENT EXTÉRIEUR | AUSSENANSTATTUNG | OUTDOOR FITTING | WYPOSAŻENIE ZEWNĘTRZNE



Gazon artificiel CALPE X-TRA S20/ S30
Kunstrasen CALPE X-TRA S20/ S30
Artificial grass CALPE X-TRA S20/ S30
Imitacja trawnika CALPE X-TRA S20/ S30



- FR** Excellent rapport qualité-prix. Aspect très naturel du gazon décoratif à 3 couleurs de filaments.
- DE** Ausgezeichnetes Preis-Qualität Verhältnis. Natürliches Aussehen in einem dekorativen Kunststoffrasen mit 3 farbige Fasern.
- EN** Excellent price-quality ratio. Very natural aspect of the 3 coloured filament decorative grass.
- PL** Doskonały stosunek jakości do ceny. Ozdobny trawnik z włóknami w trzech kolorach o bardzo naturalnym wyglądzie.

📦		±Δ	m	±mm	📄	🚚
22040010	8422502 021512	S20	2x4	22	1	36
22040011	8422502 435357	S20	2x10	22	1	16
22040012	8422502 354023	S20	2x20	22	1	9
22050020	8422502 616398	S30	2x4	30	1	36
22050021	8422502 994625	S30	2x10	30	1	12
22050022	8422502 231355	S30	2x20	30	1	9

CALPE S20

N° points | Anzahl der Stiche | No. Stitches | Liczba ściegów: 13.650/ m²
 Drainage | Wasserablauf | Drainage | Odwodnienie: 60 l/ m²
 Poids | Gewicht | Weight | Waga: 1.521 g/ m²



CALPE S30

N° points | Anzahl der Stiche | No. Stitches | Liczba ściegów: 13.650/ m²
 Drainage | Wasserablauf | Drainage | Odwodnienie: 60 l/ m²
 Poids | Gewicht | Weight | Waga: 1.710 g/ m²



Autres caractéristiques | Andere Merkmale | Other features | Inne cechy

Résistance | Widerstand | Resistance | Odporność
 Nettoyage | Reinigung | Cleaning | Czyszczenie
 Reprend sa forme après le piétinement | Keine Trittsuren
 Tread recovery | Odzyskanie śladu stopy
 Douceur | Weich | Softness | Gładkość
 Aspect naturel | Natürliches aussehen | Natural look | Naturalny wygląd

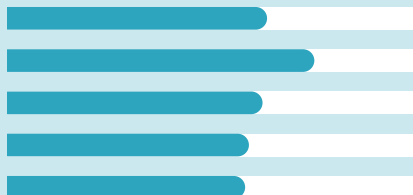



Gazon artificiel STANDARD S6
Kunstrasen STANDARD S6
Artificial grass STANDARD S6
Imitacja trawnika STANDARD S6



- FR** Gazon type moquette, gamme basique. Notre solution la plus économique en gazon!
- DE** Der Standard-Kunstrasen ist unsere günstigste Lösung und ideal für diejenigen, die nicht zu viel für einen Kunstrasen ausgeben möchten.
- EN** This carpet-type turf is from the basic range. It's our most economical solution, ideal for those who don't want to make a big investment in artificial grass.
- PL** Trawnik dywanowy z linii podstawowej. Najbardziej ekonomiczne rozwiązanie, jeśli chodzi o gamę sztucznych trawników.

🏠		±Δ	m	±Δmm	📦	🚚	
22030017	8422502 886654	S6	1x5	6	1	18	NEW!
22030018	8422502 101368	S6	1x25	6	1	4	NEW!
22030019	8422502 704071	S6	2x5	6	1	18	NEW!
22030020	8422502 744633	S6	2x10	6	1	16	NEW!
22030021	8422502 933693	S6	2x25	6	1	4	NEW!

STANDARD S6	
N° points Anzahl der Stiche No. Stitches Liczba ściegów:	70.560/ m ²
Drainage Wasserablauf Drainage Odwodnienie:	35 l/ m ²
Poids Gewicht Weight Waga:	595 g/ m ²



Autres caractéristiques Andere Merkmale Other features Inne cechy	
Résistance Widerstand Resistance Odporność	<div style="width: 90%;"></div>
Nettoyage Reinigung Cleaning Czyszczenie	<div style="width: 85%;"></div>
Reprend sa forme après le piétinement Keine Trittspuren Tread recovery Odzyskanie śladu stopy	<div style="width: 80%;"></div>
Douceur Weich Softness Gładkość	<div style="width: 20%;"></div>
Aspect naturel Natürliches aussehen Natural look Naturalny wygląd	<div style="width: 10%;"></div>

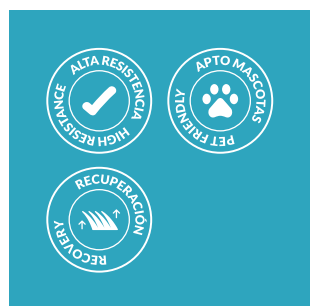

AMÉNAGEMENT EXTÉRIEUR | AUSSENANSTATTUNG | OUTDOOR FITTING | WYPOSAŻENIE ZEWNĘTRZNE



Gazon artificiel STANDARD S8 Kunstrasen STANDARD S8 Artificial grass STANDARD S8 Imitacja trawnika STANDARD S8



- FR** Ce gazon de type moquette offre une solution bon marché, avec un aspect plus dense que le STANDARD S6 C'est une solution idéale pour ceux qui veulent gazon artificiel pour un budget très raisonnable.
- DE** Ein Teppichrasen des Basissortiment. Unsere preisgünstigste Kunstrasenlösung.
- EN** It is an entry-level carpet grass. Our most economical solution in artificial turf.
- PL** Jest to podstawowa trawa dywanowa. Nasze najbardziej ekonomiczne rozwiązanie w zakresie sztucznej trawy.

📦		±↑↓	m	±↓mm	📦	🚚	
22030022	8422502 787210	S8	1x5	8	1	25	NEW!
22030023	8422502 621552	S8	1x25	8	1	5	NEW!
22030024	8422502 502356	S8	2x5	8	1	36	NEW!
22030025	8422502 359790	S8	2x10	8	1	25	NEW!
22030026	8422502 400225	S8	2x25	8	1	5	NEW!

STANDARD S8

N° points | Anzahl der Stiche | No. Stitches | Liczba ściegów: 70.560/ m²

Drainage | Wasserablauf | Drainage | Odwodnienie: 35 l/ m²

Poids | Gewicht | Weight | Waga: 720 g/ m²



8 mm

Autres caractéristiques | Andere Merkmale | Other features | Inne cechy

Résistance | Widerstand | Resistance | Odporność

Nettoyage | Reinigung | Cleaning | Czyszczenie

Reprend sa forme après le piétinement | Keine Trittspuren
Tread recovery | Odzyskanie śladu stopy

Douceur | Weich | Softness | Gładkość

Aspect naturel | Natürliches aussehen | Natural look | Naturalny wygląd



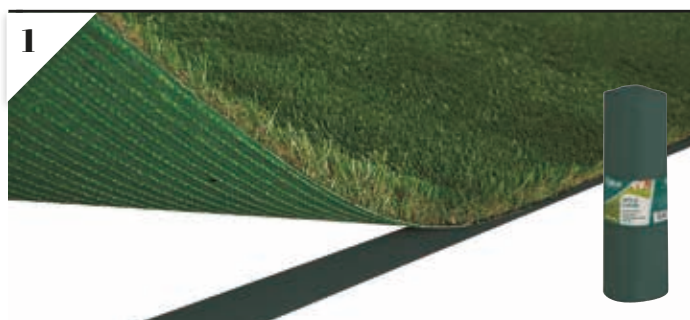

	🏠	📏	Produit Produkt Product	m	cm	📦	🚚
1	22020016	8 422502 12634 7	Bande pour colle bi-composants 30m. Zweiseitiges Klebeband 30 m. für Zweikomponentenkleber	30	30	1	80
2	22020011	8 422502 36129 8	Joint auto-adhésif prédécoupé Selbstklebendes Zugeschnittenes Verbindungsband	5	15	10	384
2	22020012	8 422502 78686 2	Joint auto-adhésif prédécoupé Selbstklebendes Zugeschnittenes Verbindungsband	10	15	8	144
2	22020013	8 422502 86274 0	Joint auto-adhésif prédécoupé Selbstklebendes Zugeschnittenes Verbindungsband	25	15	8	1152
3	22020014	8 422502 21688 8	Bande auto-adhésive double face Doppelseitiges Klebeband	10	5	24	720
				cm	mm ø		
4	22020006	8 422502 22265 0	Agrafes fixation acier inox. Edelstahl Verbindungsklemmen (Pack 10 u.)	17x3,5	3,14	80	3150
				lt 🗑️			
5	22020007	8 422502 22562 0	Hygiénisateur Reiniger	2		6	240
				ml 🗑️			
6	22020005	8 422502 22561 3	Adhésif pour sceller le gazon artificiel Dichtungskleber	300		25	1200
				kg 🗑️			
7	22020001	8 422502 22061 8	Colle durcisseur Zweikomponentenkleber	3,3		1	144
8	22020017	8 422502 91848 5	Colle monocomposant Einkomponentenkleber	6		1	-

NEW!

AMÉNAGEMENT EXTÉRIEUR | AUSSENANSTATTUNG | OUTDOOR FITTING | WYPOSAŻENIE ZEWNĘTRZNE



Bois d'extérieur

Nous présentons notre large collection de bois d'extérieur avec des produits axés sur les clôtures, les revêtements de sol, les clôtures, les pergolas ou les jardinières. Décorez avec nos traverses et autres éléments que nous vous présentons dans cette section.

Dans *Catral Garden*, vous trouverez des produits protégés par autoclave contre la pluie, l'humidité, le rayonnement solaire ou les températures élevées. Ce traitement est fongicide et insecticide préventif. Il est également compatible avec tous les revêtements de protection et de décoration tels que les cires et les peintures.

Außenbereich Holz

Wir präsentieren unsere umfangreiche Kollektion von Holz für den Außenbereich mit Produkten für Überdachungen, Böden, Zäune, Pergolen oder Pflanzgefäße. Dekorieren Sie mit unseren Schwellen und anderen Elementen, die wir Ihnen in diesem Abschnitt zeigen.

In *Catral Garden* finden Sie Produkte, die mittels Autoklav gegen Regen, Feuchtigkeit, Sonneneinstrahlung oder hohe Temperaturen geschützt sind. Diese Behandlung wirkt fungizid und als vorbeugendes Insektizid. Es ist auch mit allen schützenden und dekorativen Beschichtungen wie Wachsen und Lacken kompatibel.

Outdoor wood

We present our wide collection of outdoor wood with products focused on screenings, floors, fences, pergolas and planters. Decorate with our slats and other elements that we show you in this section.

At *Catral Garden* you will find products protected by autoclave treatment against rain, humidity, solar radiation or high temperatures. This treatment is a fungicide and preventive insecticide. It is also compatible with all protective and decorative coatings such as waxes and paints.

Drewno do użytku zewnętrznego

Oferujemy duży wybór drewna do użytku na zewnątrz, w tym przede wszystkim do budowy ogrodzeń, nawierzchni, płotów, pergoli i kwietników. Użyj belek i innych elementów, które prezentujemy w tej kategorii do dekoracji Twojego ogrodu.

W *Catral Garden* znajdziesz produkty z drewna poddanego obróbce w autoklawie, w celu zabezpieczenia przed deszczem, wilgocią, światłem słonecznym i wysokimi temperaturami. W procesie tym stosowane są środki grzybobójcze i owadobójcze o działaniu zapobiegawczym, przy czym dopuszcza on dodatkowe zastosowanie wszelkich innych powłok ochronnych i dekoracyjnych, takich jak woski i farby.

Jardinières
Pflanzkasten
Planters
Planters

74

Reillages
Rankgitter
Trellis
Kraty ogrodowe

75

Panneaux
Paneelewände
Panels
Panele

76

Parasols
Sonnenschirme
Parasols
Osłony
przeciwstoneczne

77

Pergolas
Pergolas
Pergolas
Pergole

79

Meubles
Mobilier
Furniture
Meble

80





Jardinière carrée WILDBOX
Quadratischer Blumenkasten WILDBOX
WILDBOX Squared planter
Donica kwadratowa WILDBOX



Dimensions intérieures
Innenvermessung 31090008 > 33x33x23 cm
Inner size 31090009 > 43x43x31,5 cm
Pomiar wewnętrzny

info

		cm		
31090008	8 422502 83004 6	40x40x30	1	18
31090009	8 422502 83022 0	50x50x38,5	1	12



Jardinière rectangulaire WILDBOX
Rechteckiger Blumenkasten WILDBOX
WILDBOX Rectangular planter
Donica prostokątna WILDBOX



- * Sans doublure intérieure
- * Ohne Innenfutter
- * Inner lining not included
- * Bez wykładziny

Dimensions intérieures
Innenvermessung 31090012 > 91x41x31 cm
Inner size 31090016 > 71x31x25 cm
Pomiar wewnętrzny

info

		cm		
31090012	8 422502 83023 7	100x50x38,5	1	6
31090016	8 422502 91652 8	80x40x32	1	9*



Jardinière avec feutre non tissé WINDOWBOX | Rechteckiger Blumenkasten mit Vlies WINDOWBOX
WINDOWBOX Planter with mesh
Donica z siatką WINDOWBOX



Contient un feutre non-tissé 60 g/m²
 Inklusive Unkrautvlies 60 g/m²
 Geotextile mesh included 60 g/m²

Dimensions intérieures
Innenvermessung 31090017 > 62x22x20 cm
Inner size 31090018 > 82x32x27 cm
Pomiar wewnętrzny

info

		cm		
31090017	8 422502 24763 9	70x30x28	1	12
31090018	8 422502 04948 6	90x40x33	1	9



Trellage pour jardinière
Gitter für Pflanzkasten
Trellis for planters
Kratka do donicy



📦	📏	cm	📄	📦
31090001	8 422502 83102 9	40x150x4	1	24 ^{*1}
31090002	8 422502 83103 6	90x150x4	1	12 ^{*2}

Trellage arrondi pour jardinière
Gitter für Bogenpflanzkasten
Arch trellis for planters
Kratka łukowa do donicy



📦	📏	cm	📄	📦
31090003	8 422502 83106 7	90x150x4	1	12 ^{*3}

^{*1} Treillis correspondant à la jardinière... | Eifersucht der Gärtnerin gegenüber | Trellis for the gardener... | Kratka pasująca do donicy... Ref. 31090009 || ^{*2} Treillis correspondant à la jardinière... | Eifersucht der Gärtnerin gegenüber | Trellis for the gardener... | Kratka pasująca do donicy... Ref. 31090012 || ^{*3} Treillis correspondant au jardinier... | Eifersucht der Gärtnerin gegenüber | Trellis for the gardener... | Kratka pasująca do donicy... Ref. 31090012



Trellis carrés WINDOWNATURE
Quadratisches Rankgitter WINDOWNATURE
WINDOWNATURE Squared trellis
Kratka kwadratowa WINDOWNATURE



- FR** Panneau en bois de pin traité. Taille 11,5 cm. Idéal pour placer sur les jardinières.
- DE** Behandelte Kiefernholzplatte. Größe 11,5 cm. Ideal zum Aufstellen auf die Pflanzgefäße.
- EN** Panel of treated pine wood. Ideal for placing on top of the planters.
- PL** Obrobiony panel z drewna sosnowego. Kwadraty o wymiarach 11,5 cm. Idealny dodatek do donic.



Non inclus
 Nicht Verzeichnet
 Not included
 Nieobjęty
 Pg> 74



11,5 cm

31070008 > 31090016 / 31090017
 31070009 > 31090012

info

📦	📏	cm	📄	📦
31070008	8 422502 44582 0	60x180x2	1	36
31070009	8 422502 54066 2	90x180x2	1	36



Panneau droit | Gerade paneelwand
Straight panel | Panel prosty



Icon	Icon	cm	Icon	Icon
31070001	8 422502 77001 4	180x180x2,5	1	40

Panneau Arche | Bogen-Paneelzaun
Arch-shaped panel | Panel łukowy



Icon	Icon	cm	Icon	Icon
31070002	8 422502 77002 1	180x180x4	1	40



Panneau Treillage droit | Gerader Rankzaun
Straight trellis Panel
Panel kratkowy prosty



Icon	Icon	cm	cm	Icon
31070004	8 422502 77011 3	180x90x3	9x9	38
31070005	8 422502 77010 6	180x180x4,4	9x9	24

Panneau Treillage arche | Gebogener Rankzaun
Arched trellis Panel
Panel kratkowy łukowy



Icon	Icon	cm	cm	Icon
31070003	8 422502 77012 0	180x180x4,4	9x9	24

Poteaux de raccord | Verbindungspfosten
Connection posts | Stupki łączące



Icon	Icon	cm	Icon	Icon
31040004	8 422502 80042 1	180x7x7	1	84
31040007	8 422502 80043 8	180x9x9	1	55



Parasol | Sonnenschirme | Parasol Parasol słoneczny



🏠	📏	Product	mø☂	cm ø	🚚
31110008	8 422502 17012 8	Formentera	2,5	3,5x235	56
31110010	8 422502 17004 3	Málaga	3	3,8x260	42
31110009	8 422502 17010 4	Ibiza	3,5	4,8x270	36

Pied parasol | Sonnenschirmfuß | Parasol Base Stopa do parasola słonecznego



25 mm
38 mm
40-42 mm



🏠	📏	cm ø	📦	🚚
31110011	8 422502 41015 6	Univ.	10	180



Parasol bruyère Sonnenschirm aus Heidekraut Briar parasol Wrzosowy parasol słoneczny



1 Kit Parasol en Bruyère Ø 2 m | Sonnenschirm-Kit aus Heidekraut Ø 2 m
Briar Parasol Kit Ø 2 m | Zestaw Parasol wrzosowy Ø 2 m

🏠	📏	mø☂	📦	🚚
31110005	8 422502 65002 6	2	1	8
31110002	8 422502 63009 7	2	1	-
31050013	8 422502 80108 4	-	1	120

2 Kit Parasol en Bruyère Ø 2,2 m | Sonnenschirm-Kit aus Heidekraut Ø 2,2 m
Briar Parasol Kit Ø 2,2 m | Zestaw Parasol wrzosowy Ø 2,2 m

🏠	📏	mø☂	📦	🚚
31110006	8 422502 65022 4	2,2	1	8
31110003	8 422502 63010 3	2,2	1	-
31050013	8 422502 80108 4	-	1	120

3 Kit Parasol en Bruyère Ø 2,4 m | Sonnenschirm-Kit aus Heidekraut Ø 2,4 m
Briar Parasol Kit Ø 2,4 m | Zestaw Parasol wrzosowy Ø 2,4 m

🏠	📏	mø☂	📦	🚚
31110007	8 422502 65024 8	2,4	1	8
31110004	8 422502 63011 0	2,4	1	-
31050013	8 422502 80108 4	-	1	120



Parasol en Sparte | Sonnenschirm aus Spartogras Esparto Parasol | Parasol z trawy Esparto

4 Kit Parasol en Sparte Ø 1,9 m | Sonnenschirm-Kit aus Spartogras Ø 1,9 m
Esparto Parasol Kit Ø 1,9 m | Parasol Esparto Zestaw Ø 1,9 m

📦	📏	mø☂	📦	🚚
31110017	8 422502 61611 4	1,9	2	- NEW!
31110020	8 422502 28398 9	1,75	1	- NEW!
31050013	8 422502 80108 4	-	1	120

5 Kit Parasol en Sparte Ø 2,2 m | Sonnenschirm-Kit aus Spartogras Ø 2,2 m
Esparto Parasol Kit Ø 2,2 m | Parasol Esparto Zestaw Ø 2,2 m

📦	📏	mø☂	📦	🚚
31110018	8 422502 60625 2	2,2	2	- NEW!
31110002	8 422502 63009 7	2	1	-
31050013	8 422502 80108 4	-	1	120

6 Kit Parasol en Sparte Ø 2,4 m | Sonnenschirm-Kit aus Spartogras Ø 2,4 m
Esparto Parasol Kit Ø 2,4 m | Parasol Esparto Zestaw Ø 2,4 m

📦	📏	mø☂	📦	🚚
31110019	8 422502 82621 6	2,4	1	- NEW!
31110003	8 422502 63010 3	2,2	1	-
31050013	8 422502 80108 4	-	1	120



Couverture en Bruyère | Heidekrautmantel Heather mantle | Plandeka wrzosowa

📦	📏	mø☂	Pack	📦	🚚
31110005	8 422502 65002 6	2	1	1	8
31110006	8 422502 65022 4	2,2	2	1	8
31110007	8 422502 65024 8	2,4	3	1	8



Couverture en Sparte | Spartograsmantel Esparto mantle | Płótno trawiaste Esparto

📦	📏	mø☂	Pack	📦	🚚
31110017	8 422502 61611 4	1,9	4	2	- NEW!
31110018	8 422502 60625 2	2,2	5	2	- NEW!
31110019	8 422502 82621 6	2,4	6	1	- NEW!



Anneau parasol | Rahmen für Sonnenschirm Ring for parasol | Kapelusz parasola stonecznego

📦	📏	mø☂	Pack	📦	🚚
31110020	8 422502 28398 9	1,75	4	1	NEW!
31110002	8 422502 63009 7	2	1/5	1	
31110003	8 422502 63010 3	2,2	2/6	1	
31110004	8 422502 63011 0	2,4	3	1	



Poteau pour parasol | Pfahl für Sonnenschirm | Post for parasol Słupek do parasola stonecznego

📦	📏	cm	cm ø	Pack	📦	🚚
31050013	8 422502 80108 4	250	9,5	U	1	120





Kit pergola | Pergola bausatz
Pergola kit | Zestaw pergola

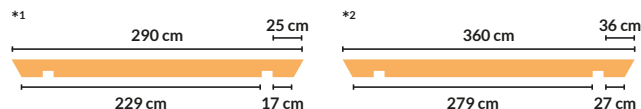

🏠	📏	cm	cm	📦	🚚
31080015	8 422502 16756 2	300x250	7x7	1	15
31080006	8 422502 83205 7	400x360	9x9	1	9
31080005	8 422502 83210 1	400x360	12x12	1	6

🏠	📏	Product	cm	📦	🚚
31080001	8 422502 83050 3	Cavalier	4,5x9x290	1	120 ^{*1}
31080002	8 422502 83051 0	Cavalier	4,5x9x360	1	120 ^{*2}
31080004	8 422502 83080 0	Escuadra	4,5x9x50	1	360
31080007	8 422502 83070 1	Listón	4,5x9x240	1	120
31080008	8 422502 83071 8	Listón	4,5x9x360	1	120
31080009	8 422502 83072 5	Listón	4,5x9x400	1	120
31080012	8 422502 83055 8	Poste	9x9x240	1	55
31080013	8 422502 83056 5	Poste	9x9x270	1	55
31080010	8 422502 83060 2	Poste	12x12x240	1	40
31080011	8 422502 83061 9	Poste	12x12x270	1	40



Choisissez la pergola qui correspond à vos besoins | Wählen Sie die Pergola, die Ihren Bedürfnissen am meisten entspricht | Choose the best pergola for you | Wybierz pergolę na miarę Twoich potrzeb

Kit Pergola
31080015

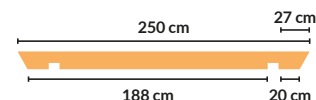

Surface couverte Oberfläche Upper surface	1 u.	3x2,5 m
Poteaux Pfosten Posts	4 u.	7x7x240 cm
Cavaliers Kavalieri Cavaliers	6 u.	3,5x7x250 cm
Liteaux Leisten Slats	2 u.	3,5x7x300 cm
Équerres Winkel Brackets	4 u.	3,5x7x50 cm

Kit Pergola
31080006

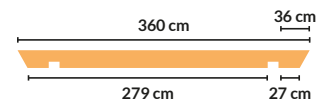

Surface couverte Oberfläche Upper surface	1 u.	4x3,6 m
Poteaux Pfosten Posts	6 u.	9x9x240 cm
Cavaliers Kavalieri Cavaliers	8 u.	4,5x9x360 cm
Liteaux Leisten Slats	4 u.	4,5x9x200 cm
Équerres Winkel Brackets	8 u.	4,5x9x50 cm

Kit Pergola
31080005

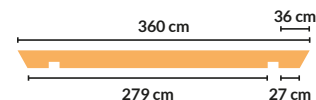

Surface couverte Oberfläche Upper surface	1 u.	4x3,6 m
Poteaux Pfosten Posts	6 u.	12x12x240 cm
Cavaliers Kavalieri Cavaliers	8 u.	4,5x9x360 cm
Liteaux Leisten Slats	4 u.	4,5x9x200 cm
Équerres Winkel Brackets	8 u.	4,5x9x50 cm



Table Picnic Superior Hochwertiger Picknicktisch Superior Picnic Table Górny stół piknikowy



- FR** Nouvelle table Pique nique en bois, les interstices réduits entre les lattes permettent une qualité supérieure et un excellent confort.
- DE** Neuer verbesserter Picknicktisch aus Holz. Es bietet ein robusteres Gefühl und mehr Komfort dank der kürzeren Abstände zwischen den Dielen.
- EN** New improved wooden picnic table. It offers a more robust feel and greater comfort thanks to the smaller separation of the boards.
- PL** Nowy ulepszony drewniany stół piknikowy. Dzięki mniejszej separacji desek oferuje bardziej wytrzymałe odczucia i większy komfort.

Icon	Icon	cm	Icon	Icon
31100011	8 422502 85955 9	180X160X71	1	6 NEW!



Table Picnic | Picknick Tisch Picnic Table | Stół piknikowy



- FR** La table en bois Picnic est prévue pour une utilisation extérieure, elle peut être utilisée dans les zones de jeux, les zones de pique-nique, les jardins, les champs, etc.
- DE** Der Holztisch "Picnic" ist für den Einsatz im Freien hergestellt. Einsatzbereiche sind Garten, Terrasse, Spielplatz.
- EN** The Picnic table is intended for outdoor use, so it can be used in play areas, picnic areas, gardens, fields, etc.
- PL** Drewniany stół piknikowy przeznaczony do użytku zewnętrznego, można go postawić na placach zabaw, terenach piknikowych... a także w ogrodach, na otwartych przestrzeniach i w innych miejscach.

Icon	Icon	cm	Icon	Icon
31100005	8 422502 83165 4	72x172x159	1	7



Table Picnic enfantine Kinderpicknicktisch Children's Picnic Table Stół piknikowy dla dzieci



- FR** Nouvelle table Picnic en bois conçue pour que les enfants puissent en profiter au jardin ou en terrasse.
- DE** Neuer Picknicktisch aus Holz. Es wird die Kleinen in Ihrem Garten oder Terrasse begeistern.
- EN** New picnic table made of wood. Children will enjoy this beautiful and useful table on the terrace or in the garden.
- PL** Nowa mała drewniana stół piknikowy. Hará disfrutar a los más pequeños en tu jardín o terraza.

Icon	Icon	cm	Icon	Icon
31100012	8 422502 44738 1	90x90x56	1	6 NEW!



TRUNKBOX Coffre bois
TRUNKBOX Abschluss für Kunsthecken
TRUNKBOX Trunk wood
TRUNKBOX Kufer drewniany

- FR** Coffre en bois traité, avec couvercle pour ranger des outils ou des accessoires de jardin.
- DE** Holzkiste aus behandeltem Holz zur Aufbewahrung von Werkzeugen oder Gartenzubehör.
- EN** Treated wooden trunk, with cover for storing garden tools or accessories.
- PL** Kufer do przechowywania narzędzi lub akcesoriów ogrodniczych zamykany na pokrywę, wykonany z impregnowanego drewna.



🏠	📏	cm	📄	📦
31100009	8 422502 91406 7	100x50x60	1	16



Abri-bûche | Kaminholzregal
Woodshed | Drewutnia

- FR** Bois de Pin traité de couleur orangée présentant une toile asphaltique dans la partie supérieure. De plus, il incorpore la visserie en acier inoxydable et une maille géotextile dans la partie postérieure en couleur noire.
- DE** Orangerfarbenes behandeltes Kiefernholz oben mit Bitumenfolie abgedeckt. Beinhaltet zudem ein rostfreies Stahlschraubenkit und eine schwarze Geotextil- Rückwand.
- EN** Treated orange-coloured pine wood with asphalt fabric on top. In addition, it incorporates stainless steel screws and a geotextile mesh in the black back.
- PL** Składzik na opał wykonany z obrobionego drewna sosnowego w pomarańczowym odcieniu z warstwą bitumiczną na dachu. W zestawie osprzęt ze stali nierdzewnej, tył wyłożony czarną siatką z geowłókniny.



info
 Comprend la maille géotextile, la toile asphaltique et la boulonnerie

Enthält Geotextil-Netzmasche, Bitumenplane und Schraubenkit.

It includes geotextile mesh, asphalt fabric and fasteners

W zestawie siatka z geowłókniny, rolka papy i osprzęt

🏠	📏	cm	📄	📦
31130001	8 422502 52975 9	100x140x60	1	7

Traverse | Schwellen | Slats | Belki

- FR** Traverses en bois de grande qualité destinées à la création de jardins et d'espaces verts sur mesure.
- DE** Hochwertige Holzbalken für die maßgerechte Gestaltung von Gärten und begrüneten Bereichen.
- EN** High-quality wooden beams and slats for gardens and custom-designed green.
- PL** Belki drewniane wysokiej jakości do tworzenia konstrukcji na wymiar w ogrodach i na terenach zielonych.



📦	📏	cm	📄	🚚
31100006	8 422502 90001 5	10x200x20	1	40
31100007	8 422502 90002 2	10x250x20	1	40

Poteaux en bois | Stützpfeosten
Wooden post | Stupki drewniane

📦	📏	cm	cm ø	📄	🚚
31050001	8 422502 800902	120	4	1	500
31050002	8 422502 800032	150	4	1	500
31050003	8 422502 800018	180	4	1	500
31050004	8 422502 800025	200	4	1	500
31050005	8 422502 8000490	250	4	1	500
31050006	8 422502 800063	180	6	1	255
31050007	8 422502 800070	200	6	1	255
31050008	8 422502 800087	250	6	1	255
31050009	8 422502 800117	180	8	1	143
31050010	8 422502 800124	200	8	1	143
31050011	8 422502 800131	250	8	1	143
31050012	8 422502 800155	300	8	1	143
31050014	8 422502 800186	250	10	1	90
31050015	8 422502 800193	300	10	1	90
31050016	8 422502 800230	250	12	1	64
31050017	8 422502 800247	300	12	1	64

Liteaux en bois | Holzlatten
Wooden slats | Listwy drewniane

📦	📏	cm	📄	🚚
31060001	8 422502 80055 1	4,5x4,5x300	6	240
31060002	8 422502 80051 3	7x3x300	6	210
31060003	8 422502 80053 7	7x7x300	2	208
31060004	8 422502 80054 4	9x9x300	2	120
31060005	8 422502 80050 6	9,5x2x300	4	216
31060006	8 422502 80052 0	12x3x300	4	120

Bords, clôtures et sols

Chez *Catral Garden*, nous proposons une sélection exclusive de clôtures et de bordures écologiques fabriquées avec notre propre matériau exclusif LOP®. Ces produits sont 100 % recyclables et d'une excellente qualité, et présentent un grand réalisme et un aspect naturel.

En plus d'être très réalistes, ils sont résistants au soleil et à l'eau, ce qui leur donne une durée de vie beaucoup plus longue que celle du bois non protégé. Ils constituent également le complément idéal pour délimiter les zones et les espaces dans votre jardin.

En outre, nous proposons une large gamme de bordures et de clôtures en bois autoclavé 3, ainsi que des sols en LOP® et en bois, bénéficiant de la qualité et de la garantie *Catral*.

Beetabgrenzungen, Zäune und Bodenbeläge

Bei *Catral Garden* haben wir eine exklusive Auswahl an ökologischen Zäunen und Einfassungen aus unserem eigenen LOP®-Material. Diese Produkte sind zu 100 % recycelbar und zeichnen sich durch eine hervorragende Qualität aus, die mit einem hohen Maß an Realismus und Natürlichkeit einhergeht.

Sie sind nicht nur sehr realistisch, sondern auch sonnen- und wasserbeständig, sodass sie viel länger halten als ungeschütztes Holz. Sie sind auch die ideale Ergänzung, um Bereiche und Räume im Garten abzugrenzen.

Darüber hinaus bieten wir eine breite Palette von Einfassungen und Zäunen mit Autoclave 3 behandeltem Holz sowie LOP® und Holzfußböden mit hoher Qualität und *Catral*-Garantie.

Borders, fences and floors

At *Catral Garden*, we have an exclusive selection of ecological fences and borders made with our own LOP® material. These products are 100% recyclable and are of excellent quality, accompanied by a great realism and naturalness.

Apart from being very realistic, they are resistant to the sun and water, which will allow them to last much longer than unprotected wood. They are also the ideal complement for delimiting areas and spaces within the garden.

In addition, we offer a wide range of wooden borders and fences treated in Autoclave 3, as well as LOP® and wooden flooring, with fine quality and the *Catral* guarantee.

Obrzeża, płoty i nawierzchnie

Catral Garden oferuje ekskluzywny wybór przyjaznych dla środowiska płotów i obrzeży wykonanych z opracowanego przez nas materiału LOP®. Są to produkty najwyższej jakości, w 100% nadające się do recyklingu, o naturalnym wyglądzie, idealnie imitujące drewno.

Oprócz naturalnego wyglądu, produkty te są odporne na światło słoneczne i wodę, co zapewnia znacznie dłuższy okres użytkowania w stosunku do produktów z surowego drewna. Stanowią również doskonałe uzupełnienie do wyznaczania stref i przestrzeni w ogrodzie.

Oferujemy również bogaty asortyment obrzeży i płotów z drewna poddanego obróbce w autoklawie (III klasa zabezpieczenia) a także nawierzchni ogrodowych z LOP® oraz drewnianych. Najwyższa jakość z gwarancją firmy *Catral*.

Bordures et clôtures
Beetabgrenzungen
und zäune
Borders and fences
Palisady i ogrodzenia

84

Sols
Bodenbeläge
Floors
Podłogi

91





CLICKBORDER Pack 5 bordures Tronc LOP® | LOP® CLICKBORDER Ausführung "Tronco" – 5er Pack | CLICKBORDER- Pack 5 LOP®
Trunk borders | CLICKBORDER Palisada ogrodowa z pieńków 5 szt. LOP®

- FR** Gamme de bordures Tronc pour votre jardin en LOP®, un matériau développé par Catral. Ce produit est recyclé et recyclable, ce qui le rend unique sur le marché. Il comprend des pointes de fixation.
- DE** Sortiment an Baumstammeinfassungen für Ihren Garten aus LOP®, einem von Catral entwickelten Material. Dieses Produkt ist recycelt und wiederverwertbar, was es einzigartig auf dem Markt macht. Inklusive Befestigungsnägel.
- EN** Range of trunk borders for your garden made of LOP®, a material developed by Catral. This product is recycled and recyclable, giving it a unique status on the market. Includes fixing spikes.
- PL** Gama obrzeży ogrodowych z palików z LOP®, materiału opracowanego przez Catral. Jest to jedyny na rynku produkt wykonany z materiałów z odzysku i nadający się do dalszego recyklingu. Zawiera kołki mocujące.

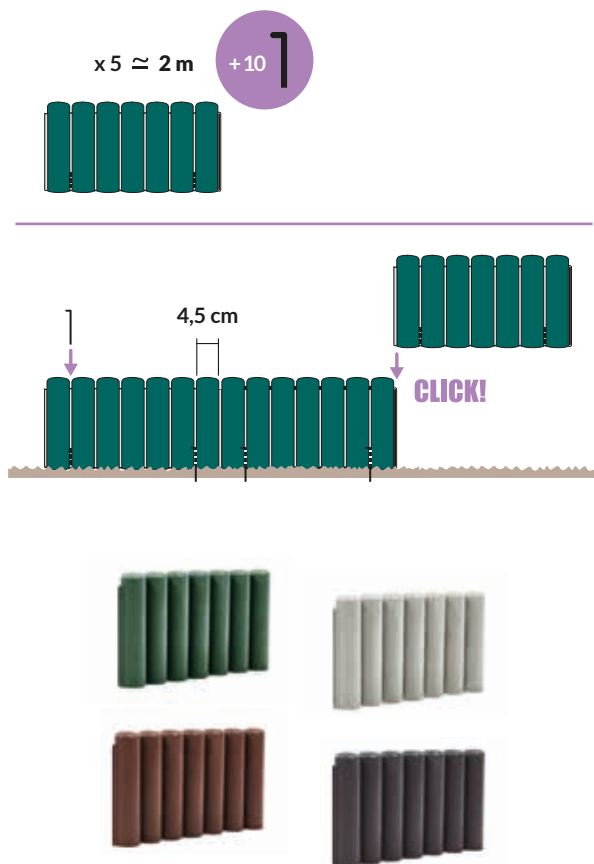

Color	Code	Barcode	cm	Spikes	Quantity
Green	49020001	8 422502 10159 7	40x20	4	128
White	49020002	8 422502 52146 3	40x20	4	128
Brown	49020003	8 422502 24711 0	40x20	4	128
Anthracite	49020009	8 422502 08302 2	40x20	4	128

AMÉNAGEMENT EXTÉRIEUR | AUSSENANSTATTUNG | OUTDOOR FITTING | WYPOSAŻENIE ZEWNĘTRZNE



Vert / Grün / Green / Zielony
 Blanc / Weiß / White / Biały

Marron / Braun / Brown / Brązowy
 Anthracite / Anthrazit / Anthracite / Antracyt



LOP LIGHT ORGANIC POLYMER by Catral



CLICKBORDER Pack 5 bordures Planche LOP® | LOP®- CLICKBORDER-BOHLE – 5er Pack
CLICKBORDER- Pack 5 LOP® Board borders
CLICKBORDER Palisada ogrodowa z desek 5 szt. LOP®

- FR** Une gamme de bordures Planche, spécialement conçues pour séparer et décorer votre jardin. Développé par Catral et fabriqué en LOP®, ce qui en fait un produit recyclé et recyclable. Il comprend des pointes de fixation.
- DE** Ein Sortiment von Einfassungsbrettern, speziell für die Abgrenzung und Dekoration Ihres Gartens. Entwickelt von Catral und hergestellt aus LOP®, was es zu einem recycelten und wiederverwertbaren Produkt macht. Inklusive Befestigungsnägel.
- EN** Range of board borders, especially for dividing and decorating your garden. Developed by Catral and manufactured in LOP®, making it a recycled and recyclable product. Includes fixing spikes.
- PL** Gama obrzeży z listew, szczególnie polecana do wydzielenia przestrzeni i jako dekoracja Twojego ogrodu. Wykonane przez Catral z materiału LOP®, pochodzącego z odzysku i nadającego się do dalszego recyklingu. Zawiera kołki mocujące.

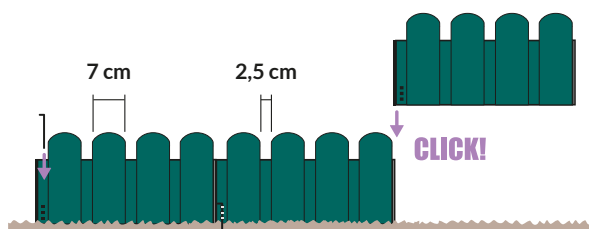
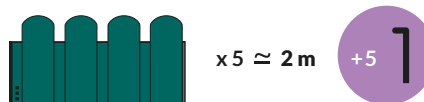

Color	Code	Quantity	Dimensions	Height	Length
Green	49010005	8 422502 86703 5	40x20	4	128
White	49010006	8 422502 60531 6	40x20	4	128
Brown	49010007	8 422502 85891 0	40x20	4	128
Dark Grey	49010017	8 422502 57647 0	40x20	4	128



Vert / Grün / Green / Zielony
 Blanc / Weiß / White / Biały

Marron / Braun / Brown / Brązowy
 Anthracite / Anthrazit / Anthracite / Antracyt



CLICKFENCE Pack 5 mini clôtures LOP®
LOP®- CLICKFENCE – 5er Pack Zaunset
CLICKFENCE- Pack 5 LOP® Fences
CLICKFENCE Minipalisada ogrodowa 5 szt. LOP®

- FR** Produit fabriqué en osier LOP®, mis au point avec un matériel écologique et réutilisable. Facile à monter grâce au système d'assemblage clipsable invisible. Permet de créer des angles avec les clôtures en toute rapidité et en toute simplicité, en s'adaptant à votre espace.
- DE** Ein aus LOP® hergestelltes Produkt. Einfachste Installation durch Verbindung mit Clickverbindern. Sehr flexibles Material.
- EN** A product made from LOP®. Easy installation by connecting with click-connectors. Very flexible material.
- PL** Produkt wykonany z tworzywa LOP®, ekologicznego materiału, który nadaje się do recyklingu. Łatwy i niewidoczny system mocowania na klik. Umożliwia tworzenie narożników w ogrodzeniu, szybko i łatwo dostosowując się do każdej przestrzeni.



Charnières non fournies
 Scharniere nicht enthalten
 Hinges not included
 Nie zawiera zawiasów

info

4,5 cm 5,5 cm x 5 ≈ 2 m

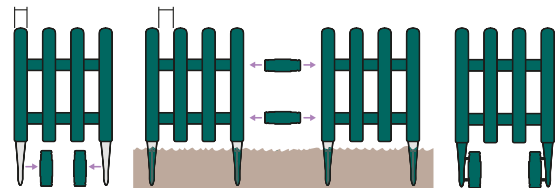

Color	Product Code	Barcode	cm	Quantity	Weight
Green	49010001	8 422502 89322 5	35x55x2	4	160
White	49010002	8 422502 48127 9	35x55x2	4	160
Brown	49010008	8 422502 37600 1	35x55x2	4	160
Anthracite	49010016	8 422502 71805 4	35x55x2	4	160



Pack 2 charnières CLICKFENCE LOP®
CLICKFENCE LOP® Eckverbinder 2er Pack
CLICKBORDER- Pack 2 LOP® Hinges
Zestaw 2 zawiasów CLICKFENCE LOP®

- FR** Produit fabriqué en LOP®, développé avec des matériaux écologiques et réutilisables.
- DE** Mit LOP® hergestelltes Produkt, entwickelt mit ökologischem und wiederverwendbarem Material.
- EN** Product made with LOP®, developed with ecological and reusable material.
- PL** Produkt wyprodukowany z LOP®, ekologicznego materiału nadającego się do ponownego przetworzenia.

Color	Product Code	Barcode	cm	Quantity	Weight
Green	49010003	8 422502 68010 8	16,5x13,8x2,5	10	1080
White	49010004	8 422502 94118 6	16,5x13,8x2,5	10	1080
Brown	49010009	8 422502 30827 9	16,5x13,8x2,5	10	1080



FLEXNATURE Bordure Planche
FLEXNATURE Rollbare Beetabgrenzung
aus Holz | FLEXNATURE Board border
FLEXNATURE Palisada ogrodowa z desek



- FR** La Bordure Planche est spécialement conçue pour s'adapter à vos besoins. Sa flexibilité vous permet de l'adapter parfaitement à la forme de votre chemin ou de votre jardinière.
- DE** Speziell auf Ihre Bedürfnisse abgestimmte Bretteinfassung. Da sie flexibel ist, lässt sie sich perfekt an die Form Ihres Weges oder Ihrer Pflanzschale anpassen.
- EN** Board borders especially designed to be adapted to your needs. Thanks to its flexibility, you can adapt it perfectly to the shape of your path or planter.
- PL** Obrzeże z desek, które idealnie dostosowuje się do Twoich potrzeb. Jego elastyczność umożliwia idealne dopasowanie do kształtu ścieżki lub kwietnika.

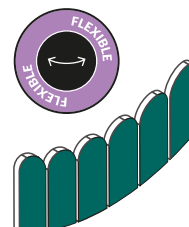

🏠	📏	cm	📦	🚚
31010012	8 422502 27408 6	120x20	1	60



Bordure flexible | Rollboard
Flexible Border | Elastyczny
rollborder



- FR** Bordure Tronc en différentes tailles et épaisseurs, parfaite pour délimiter votre jardin. Elle est conçue pour s'adapter à vos besoins grâce à sa souplesse.
- DE** Baumstammeinfassung in verschiedenen Größen und Stärken, perfekt für die Abgrenzung Ihres Gartens. Sie ist so konzipiert, dass sie dank ihrer Flexibilität an Ihre Bedürfnisse angepasst werden kann.
- EN** Trunk border in different sizes and thicknesses, perfect for delimiting your garden. It is designed to adapt to your needs thanks to its flexibility.
- PL** Obrzeże z palików o różnych rozmiarach i grubości, idealnie nadaje się do aranżacji Twojego ogrodu. Dzięki swojej elastycznej formie doskonale dostosowuje się do Twoich potrzeb.

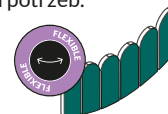

🏠	📏	cm	cm ø	📦	🚚
31010009	8 422502 17037 1	150x20	5	1	100
31010001	8 422502 76025 1	200x20	5	1	100
31010002	8 422502 76020 6	250x20	7	1	48
31010010	8 422502 36752 8	150x30	5	1	60
31010003	8 422502 76035 0	200x30	5	1	60
31010004	8 422502 76030 5	250x30	7	1	36
31010005	8 422502 76045 9	200x40	5	1	40
31010006	8 422502 76040 4	250x40	7	1	24



FIXNATURE Bordure escalier
FIXNATURE Skalenförmige Beetabgrenzung
FIXNATURE Scaled border
FIXNATURE Palisada ogrodowa z desek



- FR** Très utile pour décorer ou aménager votre jardin. Fabriquées en pin.
- DE** Sehr nützlich für die Organisation Ihres Gartens oder zur Abtrennung von Durchgängen von Anbauflächen. Hergestellt aus Kiefernholz.
- EN** Scaled border very useful for organising your garden or for separating passageways from cultivation areas. It is made of pine wood.
- PL** Bardzo przydatny do organizacji ogrodu lub do oddzielenia ciągów komunikacyjnych od obszarów uprawnych. Wykonane z drewna sosnowego.



Icon	Icon	cm	Icon	Icon
31010011	8 422502 29440 4	77x40	1	160



Bordure fixe | Feste Beeteinfassung
Fixed Border edging | Palisada stała



- FR** Bordure fixe traitée en autoclave 3, parfaite pour délimiter votre jardin et vos allées. Sur chaque extrémité, les bordures se terminent en forme de pic pour faciliter l'installation dans le sol.
- DE** Mit Autoclave 3 behandelte feste Einfassungen, perfekt für die Abgrenzung Ihres Gartens und Ihrer Gehwege. An jedem Ende endet die Einfassung in Form eines Dorns, um die Verlegung im Boden zu erleichtern.
- EN** Fixed border treated with autoclave 3, perfect for delimiting your garden and walkways. At each end, the pieces have a spike shape that makes fixing in the ground easier.
- PL** Obrzeże mocowane do gruntu, poddane obróbce w autoklawie (III klasa zabezpieczenia). Idealnie nadaje się do wydzielenia stref w ogrodzie i wytyczenia ścieżek. Na obu końcach umieszczone są ostre kołki przeznaczone do mocowania w gruncie.

Icon	Icon	cm	cmø	Icon	Icon
31010007	8 422502 76010 7	105x15	7	1	84
31010008	8 422502 76015 2	105x30	7	1	84



FENCENATURE Bordure fixe
FENCENATURE Beetabgrenzung
FENCENATURE Fixed border
FENCENATURE Palisada stała



- FR** Bordure fixe sous forme de clôture, destinée à séparer les différentes zones de votre jardin. Grâce à son design, elle donne une finition élégante à votre jardin.
- DE** Feste Einfassung in Form eines Zauns, der die verschiedenen Bereiche Ihres Gartens voneinander trennt. Dank ihres Designs verleiht sie Ihrem Garten ein elegantes Aussehen.
- EN** Fixed border in the form of a fence, designed to separate the different areas of your garden. Thanks to its design, it gives your garden an elegant finish.
- PL** Płotek mocowany do gruntu, przeznaczony do oddzielenia od siebie poszczególnych części ogrodu. Estetyczne rozwiązanie, które stanowi idealne wykończenie Twojego ogrodu.

Icon	Icon	cm	Icon	Icon
31030016	8 422502 79508 6	110x45	1	52



Mini-clôture | Mini-Zaun
Mini-fence | Miniogrodzenie



FR Mini clôture traitée en autoclave 3 et avec label FSC, conçue pour délimiter les différentes zones de votre jardin. Sur les deux extrémités, la mini-clôture intègre deux pointes pour en faciliter l'ancrage au sol.

DE Mit Autoclave 3 behandelter Mini-Zaun mit FSC-Zertifikat, zur Abgrenzung der verschiedenen Bereiche Ihres Gartens. An beiden Enden ist der Minizaun mit zwei Dornen versehen, die die Verankerung im Boden erleichtern.

EN Mini fence treated in autoclave 3 and with FSC certificate, designed to delimit the different areas of your garden. At both ends, the mini fence includes spikes to help with anchoring it.

PL Mini płotek poddany obróbce w autoklawie (III klasa zabezpieczenia), z certyfikatem FSC, idealny do oddzielenia od siebie poszczególnych części ogrodu. Na obu końcach umieszczone są ostre kolki przeznaczone do mocowania w gruncie.

📦	📏	cm	📄	🚚
31030003	8 422502 78007 5	111x28	3	132



Barrière classique
Klassischer Zaun
Classic fence
Klasyczne ogrodzenie



📦	📏	cm	📄	🚚
31030014	8 422502 56452 1	180x80	1	25
31030008	8 422502 78002 0	210x80	1	25
31030009	8 422502 78003 7	250x80	1	25
31030015	8 422502 81519 7	180x100	1	25
31030010	8 422502 78020 4	210x100	1	25
31030011	8 422502 78021 1	250x100	1	25
31030012	8 422502 78022 8	210x120	1	25



Porte de barrière classique
Tor für klassischen Zaun
Classic fence door
Klasyczna bramka ogrodzenia



📦	📏	cm	📄	🚚
31030004	8 422502 78010 5	100x80	1	20
31030006	8 422502 78012 9	100x100	1	20
31030007	8 422502 78013 6	100x120	1	20



Poteau d'ancrage | Befestigungspfosten
Anchorage Post | Stupek mocujący



📦	🏠	cm	📦	🚚
31040001	8 422502 80040 7	7x7x80	1	84
31040002	8 422502 80080 3	7x7x100	1	84
31040003	8 422502 80044 5	7x7x120	1	84
31040004	8 422502 80042 1	7x7x180	1	84
31040005	8 422502 80041 4	9x9x80	1	55
31040006	8 422502 80081 0	9x9x100	1	55
31040007	8 422502 80043 8	9x9x180	1	55



Embase pour sol dur | Bodenverankerung
Ground Anchoring | Stopa mocująca



📦	🏠	cm	📦	🚚
31120001	8 422502 81001 7	7x7x15	1	594
31120002	8 422502 81002 4	9x9x15	1	432
31120003	8 422502 81011 6	12x12x15	1	343



Piolet (acier galvanisé) | Einschlagbodenhülse
(verzinkter stahl) | Post Support with spike
(galvanised steel) | Kotek (ze stali ocynkowanej)



📦	🏠	cm	📦	🚚
31120004	8 422502 81003 1	7x7x75	1	364
31120005	8 422502 81004 8	9x9x75	1	220
31120006	8 422502 81013 0	12x12x75	1	128

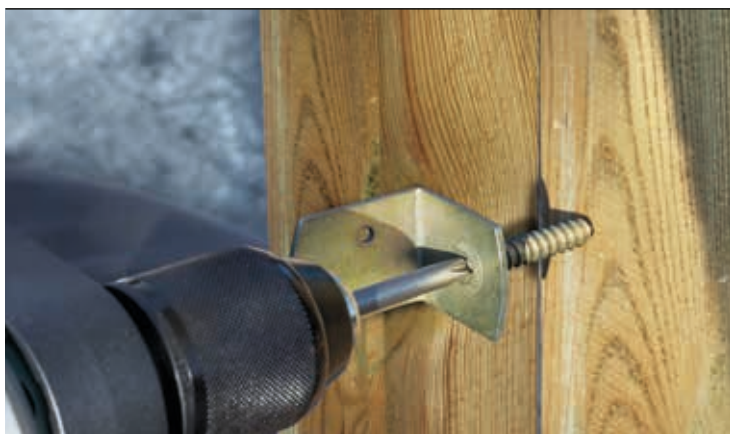

Kit équerres (électro galvanisées)
Winkelhaken-Satz (elektro galvanisiert)
Fence bracket Kit (electro-galvanised)
Zestaw wsporników (ocynkowanych elektrolitycznie)



📦	🏠	📦	🚚
31030002	8 422502 78126 3	48	1440



CLICKFLOOR Pack 9 Dalles LOP®
LOP®- CLICKFLOOR Bodenfliesen ger Pack
CLICKFLOOR Pack 9 LOP® Tiles
CLICKFLOOR Zestaw płytek LOP® 9 szt.

FR Fabriquées par Catral Garden en LOP®, un matériel écologique, recyclable, souple, résistant et réutilisable, elles offrent de multiples possibilités d'utilisation. Traitement anti-UV.

DE Hergestellt von Catral Garten aus patentiertem LOP®, ökologisches Material, recyclebar. Flexibel, langlebig und wiederverwendbar. Einfachste Montage und Verbindung. Ergibt eine perfekte Oberfläche. Mit Anti-UV-Beschichtung.

EN Manufactured by Catral Garden of patented LOP®, ecological material, recyclable. Flexible, durable and reusable. Easy assembly and connection. Result a perfect finish. With anti-UV coating.

PL Wyprodukowane przez Catral Garden z odpornego i elastycznego tworzywa LOP®. Jest to ekologiczny materiał z recyklingu, który nadaje się ponownego przetworzenia. Z powłoką chroniącą przed promieniowaniem UV, oferuje liczne zastosowania.



Aussi disponible en box présentoir de 70 unités | Für Aussteller auch in 70er Box erhältlich | Also available in 70 units display box | Also available display box of 70 units

info

🏠	📏	Product	cm	📦	🚚
40010001	8 422502 72336 2	Madera	30x30x2	2	36
40010004	8 422502 21824 0	Piedra	30x30x2	2	36
40010005	8 422502 32818 5	Pizarra	30x30x2	2	36

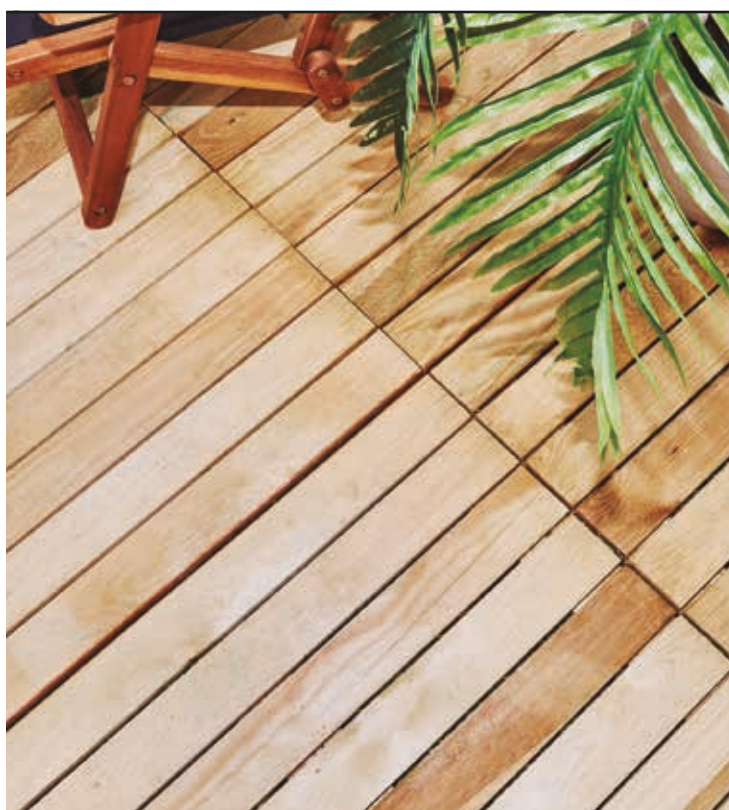

Dalle en bois de pin
Holzfliesen
Outdoor decking Tiles
Panele z drewna sosnowego



The mark of responsible forestry

FR Les dalles en bois de pin sont très légères et faciles à installer. Choisissez parmi les mesures 40x40, 50x50 et 100x100 cm selon vos goûts ou vos exigences.

DE Die Kiefernholzfliesen sind sehr leicht und einfach zu installieren. Wählen Sie zwischen den Maßen 40x40 cm, 50x50 cm und 100x100 cm.

EN The pine wood tiles are very light and easy to install. Choose between the sizes 40x40 cm, 50x50 cm and 100x100 cm.

PL Panele z drewna sosnowego są bardzo lekkie i łatwe w montażu.



🏠	📏	cm	mm I	📦	🚚
31020001	8 422502 76047 3	40x40	28	1	150
31020002	8 422502 76050 3	50x50	28	1	100
31020003	8 422502 76060 2	100x100	44	1	30
31020004	8 422502 76080 0	100x100	32	1	40

Abris de jardin et bâches

Nous élargissons notre gamme d'abris de jardin métalliques, le rangement parfait pour stocker les outils, ainsi que tout ce qui concerne le soin et l'entretien du jardin.

Nous proposons différentes tailles pour nous adapter aux besoins de nos clients, du modèle CRETA au modèle MALLORCA, idéal pour le stockage de produits de grand volume tels que les tondeuses à gazon, les outils d'élagage, les vélos et une grande variété de produits qui nécessitent un stockage important et sûr.

En outre, nos bâches de protection extérieure sont disponibles en différentes tailles et couleurs.

Gartenhäuser und Planen

Wir erweitern unser Angebot an modernisierten Gartenhäusern aus Metall, die sich perfekt für die Aufbewahrung von Werkzeugen und allem eignen, was mit der Pflege und Instandhaltung des Gartens zu tun hat.

Wir bieten verschiedene Größen an, um uns an die Bedürfnisse unserer Kunden anzupassen, vom Modell CRETA bis zum MALLORCA, ideal für die Aufbewahrung von großvolumigen Produkten wie Rasenmähern, Baumschnittwerkzeugen, Fahrrädern und einer Vielzahl von Produkten, die eine große und sichere Lagerung erfordern.

Darüber hinaus sind unsere Außenschutzmarkisen in verschiedenen Größen und Farben erhältlich.

Garden sheds and tarpaulins

We are expanding our range of upgraded metal garden sheds, the perfect storage space for tools, as well as everything for the care and maintenance of the garden.

We offer different sizes to meet the needs of our customers, from the CRETA model to the MALLORCA, ideal for storing large items such as lawnmowers, pruning tools, bicycles, and a wide variety of other products that need spacious and secure storage.

In addition, our outdoor protective tarpaulins are available in different sizes and colours.

Domki narzędziowe i markizy

Rozszerzamy naszą ofertę udoskonalonych metalowych domków ogrodowych, idealnie nadających się do przechowywania narzędzi i innych akcesoriów do pielęgnacji i konserwacji ogrodu.

Oferujemy różne rozmiary, aby dostosować się do potrzeb naszych klientów, od modelu CRETA do modelu MALLORCA, idealnego do przechowywania dużych narzędzi, takich jak kosiarki do trawy, narzędzia do przycinania, a także rowerów i innych produktów, które wymagają dużej przestrzeni i bezpiecznego przechowywania.

Oferujemy również zewnętrzne markizy ochronne, dostępne w różnych rozmiarach i kolorach.

Abris de jardin
métalliques
Metallgartenhäuser
Metal garden sheds
Metalowe szopy

93

Bâches
Planen
Tarpaulins
Markizy

97





Abri de jardin métallique STORE ROOM CRETA
Metallgerätehaus STORE ROOM CRETA
Metal shed STORE ROOM CRETA
Szopa metalowa STORE ROOM CRETA

- FR** Abri de jardin métallique compact créé pour un usage extérieur et intérieur. La toiture est monopente, ce qui permet à l'eau de pluie de s'écouler vers l'arrière de l'abri pour éviter qu'elle ne tombe sur l'accès. Deux trous dans la porte permettent d'installer un cadenas pour une sécurité accrue.
- DE** Kompaktes Metallgartenhaus, das sowohl für den Innen- als auch für den Außenbereich geeignet ist. Es hat ein Pultdach, sodass der Regen nach hinten ablaufen kann und nicht auf den Zugang fällt. In der Tür befinden sich zwei Löcher, an denen ein Vorhängeschloss angebracht werden kann, um die Sicherheit zu erhöhen.
- EN** Compact metal shed devised for both outdoors and indoors. It has a sloping roof, to evacuate rainwater at the back and thus prevent it from falling on the access area. There are two holes in the door that allow a padlock to be fitted for increased security.
- PL** Kompaktowy domek metalowy do montażu na zewnątrz lub wewnątrz. Posiada jednospadowy dach, dzięki czemu woda opadająca spływa na tył domku i nie zalewa drzwi. W drzwiach znajdują się dwa otwory, które umożliwiają założenie kłódki w celu zwiększenia bezpieczeństwa.

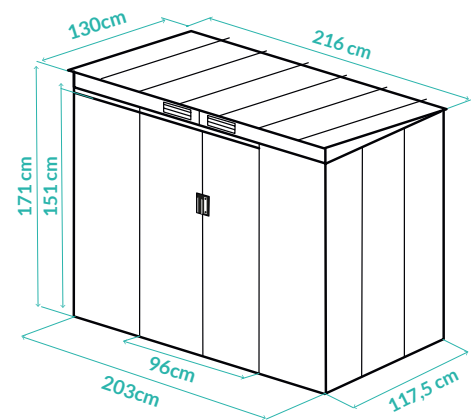

SHEET THICKNESS
0,25 mm

Hauteur de porte Türhöhe Door height Wysokość drzwi	1,51 m
Surface Oberfläche Surface Powierzchnia	2,39 m ²

info

			m (AxHxP)		
62010012	8 422502 12730 6		2,16x1,71x1,30	1	7
62010013	8 422502 90722 9		2,16x1,71x1,30	1	7



- Gris / Grau / Grey / Grey
- Vert / Grün / Green / Zielony



Abri de jardin métallique CÔRCEGA High Door
Metallgerätehaus CÔRCEGA High Door
Metal shed CÔRCEGA High Door
Szopa metalowa CÔRCEGA High Door

- FR** Modèle intermédiaire d'abris de jardin métalliques. Il possède une toiture à deux versants qui évacue la pluie vers les côtés de l'abris Il dispose d'une petite fenêtre qui permet à la lumière d'entrer et facilite une meilleure ventilation de l'intérieur. L'option de placer un cadenas sur la porte est possible.
- DE** Zwischenmodell der Metallgardenhäuser. Es hat ein Giebeldach, das den Regen zu den Seiten der Hütte ableitet. Es hat ein kleines Fenster, durch das Licht in den Innenraum gelangt, und eine bessere Belüftung. Es besteht die Möglichkeit, ein Vorhängeschloss an der Tür anzubringen.
- EN** Intermediate model of metal garden sheds. It has a pitched roof that evacuates rainwater to both sides. It has a small window, allowing the entry of light and better ventilation inside. It includes the possibility of fitting a padlock to the door.
- PL** Domek metalowy średniej wielkości. Posiada dach dwuspadowy, który odprowadza wodę opadającą na boki, a także okienko, które zapewnia dostęp światła dziennego i odpowiednią wentylację wnętrza. Konstrukcja drzwi umożliwia założenie kłódki.

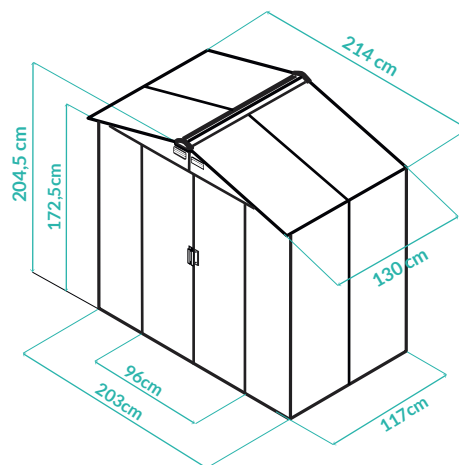

SHEET THICKNESS
0,25 mm

Hauteur de porte Türhöhe Door height Wysokość drzwi	1,725 m
Surface Oberfläche Surface Powierzchnia	2,37 m ²

info

			m (AxHxP)		
	62020003	8 422502 022953	2,14x2,045x1,30	1	6 NEW!
	62020004	8 422502 172047	2,14x2,045x1,30	1	6 NEW!

AMÉNAGEMENT EXTÉRIEUR | AUSSENAUSSTATTUNG | OUTDOOR FITTING | WYPOSAŻENIE ZEWNĘTRZNE



- Blanc / Weiß / White / Biały
- Gris / Grau / Grey / Grey



Abri de jardin métallique MENORCA High Door
Metallgerätehaus MENORCA High Door
Metal shed MENORCA High Door
Szopa metalowa MENORCA High Door

- FR** Modèle de grande taille, permettant de stocker à la fois des outils et des petites machines. Il possède une toiture à deux versants qui évacue la pluie vers les côtés de l'abri. Il dispose d'une petite fenêtre qui permet à la lumière d'entrer et facilite une meilleure ventilation de l'intérieur.
- DE** Großes Modell, in dem Sie sowohl Werkzeuge als auch kleine Maschinen unterbringen können. Es hat ein Giebeldach, das den Regen zu den Seiten des Schuppens ableitet. Es hat ein kleines Fenster, das den Lichteinfall und eine bessere Belüftung im Inneren ermöglicht.
- EN** Large model, which lets you store both tools and small machinery. It has a pitched roof that evacuates rainwater to both sides. It has a small window, allowing the entry of light and better ventilation inside.
- PL** Model duży, do przechowywania narzędzi i małych maszyn. Posiada dach dwuspadowy, który odprowadza wodę opadającą na boki, a także okienko, które zapewnia dostęp światła dziennego i odpowiednią wentylację wnętrza.

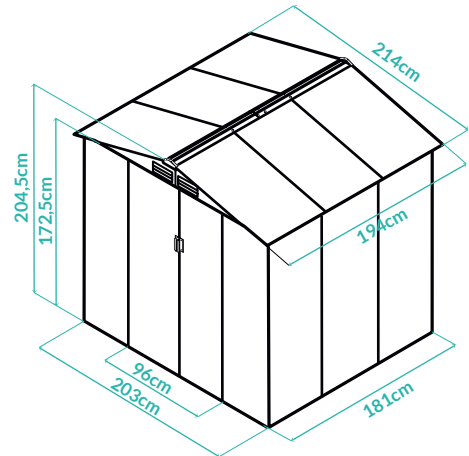

SHEET THICKNESS
0,25 mm

Hauteur de porte Türhöhe Door height Wysokość drzwi	1,725 m
Surface Oberfläche Surface Powierzchnia	3,67 m ²

info

			m (AxHxP)		
	62020005	8 422502 809837	2,14x2,045x1,94	1	5 NEW!
	62020006	8 422502 869084	2,14x2,045x1,94	1	5 NEW!



- Vert / Grün / Green / Zielony
- Gris / Grau / Grey / Grey



Abri de jardin métallique MALLORCA High Door
Metallgerätehaus MALLORCA High Door
Metal shed MALLORCA High Door
Szopa metalowa MALLORCA High Door

- FR** L'abris de jardin aux dimensions les plus grandes de la gamme Catal. Grâce à sa grande taille, il est possible d'y stocker des machines, des outils et des équipements, y compris de petits établis. Il possède une toiture à deux versants qui évacue la pluie vers les côtés de l'abri. Il dispose d'une petite fenêtre qui permet à la lumière d'entrer et facilite une meilleure ventilation de l'intérieur.
- DE** Das größte Gartenhaus der Catal-Reihe. Dank seiner Größe kann er sowohl Maschinen als auch Werkzeuge und Geräte, einschließlich kleiner Werkbänke, aufnehmen. Es hat ein Giebeldach, das den Regen an den Seiten des Gartenhauses ableitet. Es hat ein kleines Fenster, durch das Licht in den Innenraum gelangt, und eine bessere Belüftung.
- EN** The largest shed in the Catal range. Thanks to its large capacity, it can store machinery, tools and equipment, including small workbenches. It has a pitched roof that evacuates rainwater to both sides. It has a small window, allowing the entry of light and better ventilation inside.
- PL** Największy model domku narzędziowego oferowany przez Catal. Jego rozmiary umożliwiają przechowywanie maszyn, narzędzi i sprzętu, a także umieszczenie małego stołu warsztatowego. Posiada dach dwuspadowy, który odprowadza wodę opadającą na boki, oraz okienko, które zapewnia dostęp światła dziennego i odpowiednią wentylację wnętrza.

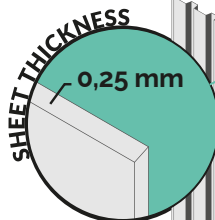
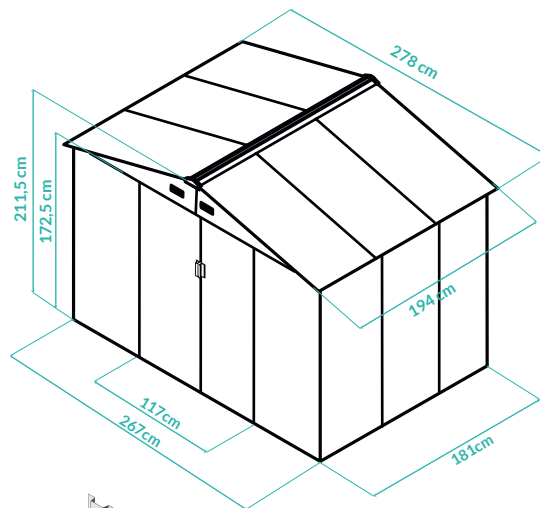

Hauteur de porte Türhöhe Door height Wysokość drzwi	1,725 m
Surface Oberfläche Surface Powierzchnia	4,83 m ²

			m (AxHxP)		
	62020007	8 422502 84878 2	2,78x2,115x1,94	1	5 NEW!
	62020008	8 422502 10081 1	2,78x2,115x1,94	1	5 NEW!

AMÉNAGEMENT EXTÉRIEUR | AUSSENANSTATTUNG | OUTDOOR FITTING | WYPOSAŻENIE ZEWNĘTRZNE



Vert / Grün / Green / Zielony
 Blanc / Weiß / White / Biały



Abri de jardin métallique TOOLS High Door
Metallgerätehaus TOOLS High Door
Metal shed TOOLS High Door
Szopa metalowa TOOLS High Door

Total
2,2 m²

Nouvelle couleur
 Neue Farben:
 New color
 Nowy kolor

IBIZA

Nouvelle hauteur de porte
 Neue Höhen Bei Eingangstüren
 New door height
 Nowa wysokość drzwi

1,85 m

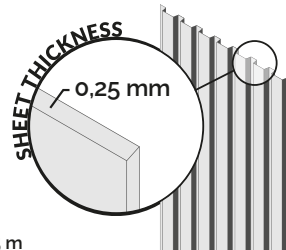

		m (AxHxP)		
62010005	8422502794638	2,13x2,21x1,29	1	8
62010006	8422502597222	2,13x2,21x1,29	1	8



Abri de jardin métallique SPACE High Door
Metallgerätehaus SPACE High Door
Metal shed SPACE High Door
Szopa metalowa SPACE High Door

Total
4,3 m²

Nouvelle couleur
 Neue Farben:
 New color
 Nowy kolor

DARK
GREY

Nouvelle hauteur de porte
 Neue Höhen Bei Eingangstüren
 New door height
 Nowa wysokość drzwi

1,85 m

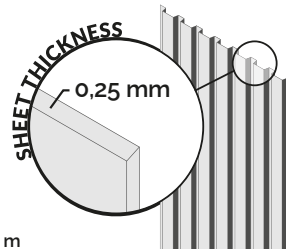

		m (AxHxP)		
62010007	8422502761012	2,34x2,17x1,71	1	8
62010008	8422502529858	2,34x2,17x1,71	1	8



Abri de jardin métallique INFINITY High Door
Metallgerätehaus INFINITY High Door
Metal shed INFINITY High Door
Szopa metalowa INFINITY High Door

Total
5,1 m²

Nueva altura de puerta
 Nova altura de porta
 Nuova altezza della porta

1,85 m

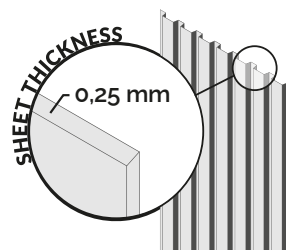

		m (AxHxP)		
62010009	8422502850976	2,36x2,21x2,33	1	7



● Gris / Grau / Grey / Grey
 ● Vert / Grün / Green / Zielow

○ Blanco / Branco / Bianco



Bâche renforcée Polyéthylène
Polyethylen Abdeckplane
Reinforced Polyethylene Tarpaulin
Markiza wzmocniona polietylenem

PE

FR La bâche de protection renforcée est une solution très fonctionnelle pour protéger les tas de bois, les barbecues, les outils, ou autres.

DE Die verstärkte Plane stellt eine sehr funktionelle Lösung zum Schutz von Holzstapeln, eingebauten Grills, Werkzeugen, Ackerbaugeräten, usw. dar.

EN This reinforced tarpaulin is a very functional solution for protecting woodpiles, brick barbecues, tools, agricultural equipment, etc.

PL Wzmocniona markiza ochronna to bardzo funkcjonalne rozwiązanie do osłony skrzynki na drewno opałowe, zamontowanych grilli, narzędzi, sprzętu i innych elementów.



			m	g/m ² Δ		
	56010007	8 422502 19060 7	3x2	70	12	504
	56010008	8 422502 19061 4	3x4	70	12	364
	56010009	8 422502 19062 1	3x5	70	12	372
	56010010	8 422502 19005 8	3x2	90	10	480
	56010011	8 422502 19010 2	3x4	90	10	280
	56010012	8 422502 19013 3	3x5	90	10	300
	56010013	8 422502 19015 7	4x6	90	10	180
	56010014	8 422502 19020 1	5x8	90	6	144
	56010015	8 422502 19025 6	6x10	90	4	80
	56010001	8 422502 19030 0	3x2	120	10	540
	56010002	8 422502 19035 5	3x4	120	8	224
	56010003	8 422502 19037 9	3x5	120	12	216
	56010004	8 422502 19040 9	4x6	120	6	96
	56010005	8 422502 19045 4	5x8	120	4	80
	56010006	8 422502 19050 8	6x10	120	3	48



Fixateur élastique | Planenspanner
Elastic tie down | Gumka mocująca

PACK 12 U.

FR Fixation élastique pour fixer parfaitement les bâches et les housses.

DE Planenspanner für den perfekten Halt von Planen und Hüllen.

EN Elastic tie down for perfect attachment of tarpaulins and covers.

PL Gumka mocująca idealnie nadaje się do mocowania markiz i pokrowców.

22020010	8 422502 22567 5	20	1440



Blanc / Weiß / White / Biały

Vert / Grün / Green / Zielony

Bleu / Blau / Blue / Niebieski

**Décoration | Dekoration
Decoration | Dekoracja**



Décoration

Nous offrons une large gamme de produits de décoration pour faire de votre maison un lieu unique.

Le bien-être dans une maison est essentiel pour le quotidien et cela se réalise, entre autres, avec une décoration soignée qui transmet la paix et la tranquillité.

Dekoration

Wir bieten eine breite Palette an Dekorationsprodukten um das Haus zu einem einzigartigen Ort zu machen.

Das Wohlbefinden in einem Haus ist für den Alltag unentbehrlich, was unter anderem durch eine sorgfältig dekorierte Umgebung erreicht wird, die Frieden und Ruhe in Ihrer Lieblingsecke vermittelt.

Decoration

We offer a wide range of decoration products to make home a special place.

The well-being in a house is essential for the day to day and this is achieved, among other things, with a careful decoration that provides peace and tranquility in your favorite place.

Dekoracja

Oferujemy szeroką gamę produktów dekoracyjnych, dzięki którym Twój dom stanie się miejscem wyjątkowym.

Dobre samopoczucie jest niezbędne na co dzień. Można je osiągnąć między innymi dzięki pięknym dekoracjom, które napelnia Twoje ulubione wnętrza ciszą i spokojem.

Plantes artificielles
Kunstpflanzen
Artificial plants
Sztuczne rośliny

100

Jardins verticaux
Vertikale Gärten
Vertical gardens
Ogrody wertykalne

106

Boules décoratives
Dekorative Kugeln
Decorative orbs
Kule ozdobne

111

Tuteurs décoratifs
Dekorative stangen
Decorative stakes
Kije dekoracyjne

112

Stores et rideaux
Jalousien und
Holzvorhänge
Blinds and curtains
Żaluzje i drewniane
zastony

113

Fruits et légumes
Künstliche Früchte
und Gemüse
Fruits & Vegetables
Owoce i warzywa

115

PVC



Plantes artificielles | Kunstpflanzen Artificial plants | Sztuczne rośliny

FR Le processus de fabrication des plantes artificielles est soigné au maximum dans tous les détails et les finitions, afin d'obtenir un grand réalisme à la fois visuel comme au toucher. Elles sont recommandées pour différentes utilisations: intérieur, domestique, commercial, dans des entreprises ou autres espaces publics.

DE Bei der Herstellung der künstlichen Pflanzen werden alle Details und Endlichkeiten genauestens berücksichtigt, wobei sowohl visueller als auch fühlender Realismus vorherrscht. Sie sind für die Verwendung im Haushalt, im Handel, in Unternehmen oder anderen öffentlichen Räumen geeignet.

EN All the finishes of the plants are very important in its manufacturing process, achieving a great visual realism and touch. These are suitable for any kind of indoor use, domestic, commercial, in corporate halls or in any other public spaces.

PL Szeroka gama rozmiarów i modeli do dekoracji wnętrz. Bujne i trwałe rośliny, które nie wymagają pielęgnacji. Proces produkcji wyróżnia się niezwykłą dbałością o szczegóły i detale wykończeniowe. W rezultacie otrzymujemy rośliny, które nie różnią się od prawdziwych. Nadają się do wszelkiego rodzaju zastosowań wewnętrznych: domowych, komercyjnych, firmowych, jak i innych przestrzeni publicznych.

🏠		Product	cm	📦	🚚
74010010	8 422502 47829 3	AGAVE	73	4	60
74010001	8 422502 64965 5	BAMBU	200	1	25
74010004	8 422502 77738 9	CHEFLERA	65	4	72
74010005	8 422502 36368 1	CHEFLERA	145	1	36
74010007	8 422502 53852 2	CICA	125	1	20
74010003	8 422502 14776 2	CROTON	140	1	36
74010006	8 422502 06378 9	DRACENA	145	1	30
74010013	8 422502 85332 8	FILODENDRO	70	8	128
74010014	8 422502 23733 3	FILODENDRO	150	1	25
74010017	8 422502 46513 2	CALATEA	49	12	216
74010002	8 422502 49292 3	CALATEA	135	1	36
74010016	8 422502 34867 1	CALATEA CEBRA	49	12	216
74010018	8 422502 63907 6	CALATEA LUISAE	9	12	216
74010008	8 422502 09637 4	LENGUA DE TIGRE	105	1	25
74010009	8 422502 58094 1	LENGUA DE TIGRE BIC	105	1	25
74010020	8 422502 63938 0	MONSTERA	135	1	25
74010011	8 422502 78468 4	NOLINA	185	1	30
74010012	8 422502 16247 5	PALMERA	120	1	36
74010019	8 422502 95214 4	PATA DE ELEFANTE	150	1	36
74010015	8 422502 84955 0	TARO	100	1	36
74010026	8 422502 18732 4	ARACEA	120	1	30
74010027	8 422502 98665 1	AGAVE MINI	98	1	16
74010028	8 422502 31089 0	SANSEVIERIA	70	4	48
74010029	8 422502 92598 8	NOLINA MINI	75	2	24
74010030	8 422502 48500 0	TARO	73	8	72
74010031	8 422502 59330 9	VELA DEL VIENTO	105	1	30
74010032	8 422502 51903 3	ANTURIO	95	1	30
74010033	8 422502 18406 4	ARCOIRIS	170	1	15
74010034	8 422502 97322 4	CACTUS SAGUARO	145	1	12
74010035	8 422502 27832 9	CACTUS SAGUARO	82	4	24
74010036	8 422502 13335 2	CACTUS ALOE	81	1	16
74010037	8 422502 82583 7	CACTUS ORGANO	120	1	6
74010038	8 422502 71316 5	CACTUS ORGANO	64	4	24
74010039	8 422502 82647 6	CACTUS EUPHORBIA S.	90	1	16
74010040	8 422502 38152 4	CACTUS EUPHORBIA S.	57,5	6	36
74010041	8 422502 19734 7	CACTUS STETSONIA C.	64	6	18
74010042	8 422502 02596 1	CACTUS STETSONIA C.	43	12	96
74010043	8 422502 85886 6	FICUS LYRATA	120	1	36
74010044	8 422502 16642 8	FICUS LYRATA	90	1	36
74010045	8 422502 09559 9	AVE DEL PARAISO FLOR	185	1	20
74010046	8 422502 09275 8	AVE DEL PARAISO	188	1	20
74010047	8 422502 15287 2	CACTUS CASTILLO	62	6	18
74010048	8 422502 39586 6	BAMBU	180	1	- NEW!
74010049	8 422502 22643 6	OLIVO	150	1	- NEW!
74010050	8 422502 76103 6	PALMERA	180	1	- NEW!
74010051	8 422502 66646 1	PLATANERA	180	1	- NEW!



74010010 | Agave 73 cm



74010001 | Bambú 200 cm



74010004 | Cheflera 65 cm



74010005 | Cheflera 145 cm



74010007 | Cica 125 cm



74010003 | Croton 140 cm



74010006 | Drácena 145 cm



74010013 | Filodendro 70 cm



74010014 | Filodendro 150 cm

PVC



74010017 | Calatea 49 cm



74010002 | Calatea 135 cm



74010016 | Calatea Cebra 49 cm



74010018 | Calatea Luisae 49 cm



74010008 | Lengua de tigre 105 cm



74010009 | Lengua de tigre Bicolor 105 cm



74010020 | Monstera 135 cm



74010011 | Nolina 185 cm



74010012 | Palmera 120 cm



74010019 | Pata de elefante 150 cm



74010030 | Taro 73 cm



74010015 | Taro 100 cm



74010026 | Aracea 120 cm



74010027 | Agave mini 98 cm



74010028 | Sansevieria 70 cm



74010029 | Nolina mini 75 cm



74010031 | Vela del viento 105 cm



74010032 | Anturio 95 cm

PVC



74010033 | Arcoiris 170 cm



74010043 | Ficus Lyrata 120 cm



74010044 | Ficus Lyrata 90 cm



74010045 | Ave del Paraíso Flor 185 cm



74010046 | Ave del Paraíso 188 cm



74010047 | Cactus Castillo de hadas 62 cm



74010034 | Cactus Saguaro 145 cm



74010035 | Cactus Saguaro 82 cm



74010036 | Cactus Aloe 81 cm

DÉCORATION | DEKORATION | DECORATION | DEKORACJE



74010037
Cactus Organo 120 cm



74010038
Cactus Organo 64 cm



74010039
Cactus Euphorbia S. 90 cm



74010040
Cactus Euphorbia S. 57,5 cm



74010041 | Cactus Stetsonya C. 64 cm



74010042 | Cactus Stetsonya C. 43 cm



NEW!

74010048 | Bambú 180 cm



NEW!

74010049 | Olivo 150 cm



NEW!

74010050 | Palmera 180 cm



NEW!

74010051 | Platanera 180 cm



Jardins verticaux | Vertikale Gärten Vertical gardens | Ogrody wertykalne

- FR** Un élément de décoration parfait pour la maison qui ne laissera personne indifférent. Les dalles de jardin vertical peuvent être placées sur tout type de mur lisse, offrant un spectaculaire contraste que se soit à la maison, au bureau ou dans tout autre établissement. Il est possible de les découper facilement avec un cutter ou des ciseaux.
- DE** Ein perfektes Dekorationsgerät für den Haushalt, das niemanden gleichgültig lässt. Die vertikalen Gartenfliesen können an jeder glatten Wand angebracht werden und bieten einen spektakulären Kontrast, ob zu Hause, im Büro oder in einem anderen Etablissement. Außerdem ist es möglich, die Fliesen oder Rollen aller vertikalen Gartenmodelle einfach mit einem Teppichmesser oder einer Schere zu schneiden.
- EN** A decorative element perfect for home and that will not leave anyone indifferent. Vertical garden tiles can be placed on any smooth wall, offering a spectacular contrast either at home, in the office or in any place. In addition, it is possible to cut the tiles or rolls of all vertical garden models simply with a cutter or scissors.
- PL** Idealny element dekoracyjny do domu, który zachwyci każdego gościa. Panele ogrodów wertykalnych można umieścić na wybranej gładkiej ścianie, uzyskując spektakularny widok w domu, w biurze lub lokalu. Ponadto panele lub rolki wszystkich modeli ogrodów wertykalnych można z łatwością przycinać za pomocą nożyka lub nożyczek.

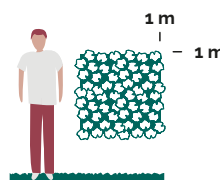

🏠		Producto	cm	📄	🚚
43040034	8 422502 06855 5	VINCA	100x100	6	36
43040035	8 422502 89536 6	BOJ	100x100	6	36
43040036	8 422502 86845 2	WILD	100x100	4	28
43040037	8 422502 33999 0	BOJ BALEAR	100x100	6	36
43040038	8 422502 73271 5	HEDRA	100x100	6	36
43040039	8 422502 44850 0	LINK	100x100	6	36
43040045	8 422502 30963 4	SAUVAGE	100x100	4	28
43040046	8 422502 22731 0	DENSE	100x100	4	24
43040047	8 422502 88531 2	JAZMIN	100x100	6	36
43040048	8 422502 91414 2	FOREST	100x100	4	24
43040049	8 422502 59700 0	MOSS	100x100	4	24
70040001	8 422502 34512 0	LIGHTED SAUVAGE	100x100	4	- NEW!
70030002	8 422502 58333 1	GRAZING	100x100	5	- NEW!
70030003	8 422502 37177 8	RIVENDEL	100x100	5	- NEW!
70030004	8 422502 65216 7	HELLENE	100x100	5	- NEW!
70030005	8 422502 37856 2	LEAFY	100x100	5	- NEW!

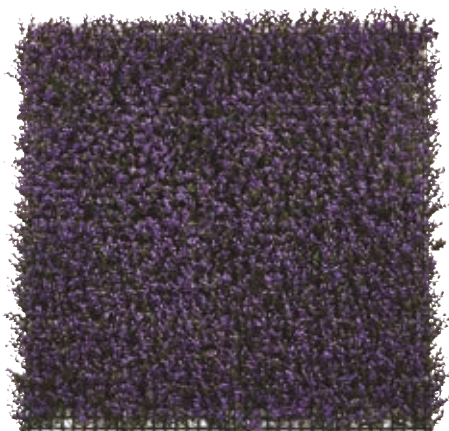

43040034 | Vinca



43040035 | Boj



43040036 | Wild



43040037 | Boj Balear



43040038 | Hedra



43040039 | Link



43040045 | Sauvage



43040046 | Dense



43040047 | Jazmin



43040048 | Forest



43040049 | Moss

NEW!



70040001 | Lighted Sauvage

Piles non incluses | Batterien nicht enthalten | Batteries not included
Baterie nie są dotychczas

NEW!



70030002 | Grazing

NEW!



70030003 | Rivendel

NEW!



70030004 | Hellene

NEW!



70030005 | Leafy



Jardin vertical LIPTUS
Vertikaler Garten LIPTUS
Vertical garden LIPTUS
Ogród wertykalny LIPTUS



- FR** Le jardin vertical Liptus est vendu en packs indivisibles de 4 dalles de 50x50 cm, de sorte qu'il peut être installé selon votre choix, même en combinant plusieurs modèles entre eux, pour créer ainsi des ambiances uniques.
- DE** Der Vertikale Garten Liptus wird in unteilbaren Packungen mit 4 Platten von 50x50 cm verkauft, sodass er auf jede beliebige Art und Weise installiert werden kann, auch in Kombination mit mehreren Modellen, um einzigartige Atmosphären zu schaffen.
- EN** The Liptus Vertical Garden is sold in indivisible packs of 4 mats of 50x50 cm, so it can be installed any way you wish, even by combining different models together to invent unique environments.
- PL** System zieleni wertykalnej Liptus, sprzedawany w niepodzielnych pakietach po 4 panele o wymiarach 50x50 cm. Można go zainstalować w dowolny sposób, łącząc ze sobą różne modele w celu stworzenia wyjątkowego otoczenia.



Icon	Barcode	cm	Icon	Icon
	43040001 8 422502790760	50x50		
			4	144



Jardin vertical ERABLE
Vertikaler Garten MAPLE
Vertical garden MAPLE
Ogród wertykalny KLON



- FR** Le jardin vertical Liptus est vendu en packs indivisibles de 4 dalles de 25x25 cm, de sorte qu'il peut être installé selon votre choix, même en combinant plusieurs modèles entre eux, pour créer ainsi des ambiances uniques.
- DE** Der Vertikale Garten Liptus wird in unteilbaren Packungen mit 4 Platten von 25x25 cm verkauft, sodass er auf jede beliebige Art und Weise installiert werden kann, auch in Kombination mit mehreren Modellen, um einzigartige Atmosphären zu schaffen.
- EN** The Liptus Vertical Garden is sold in indivisible packs of 4 mats of 25x25 cm, so it can be installed any way you wish, even by combining different models together to invent unique environments.
- PL** System zieleni wertykalnej Liptus, sprzedawany w niepodzielnych pakietach po 4 panele o wymiarach 25x25 cm. Można go zainstalować w dowolny sposób, łącząc ze sobą różne modele w celu stworzenia wyjątkowego otoczenia.



Icon	Barcode	cm	Icon	Icon
	43040016 8 422502311958	25x25		
			8	48

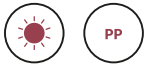

Jardin vertical CIPRÉS
Vertikaler Garten CYPRESS
Vertical garden CYPRESS
Ogród wertykalny CYPRESS

PACK
4u

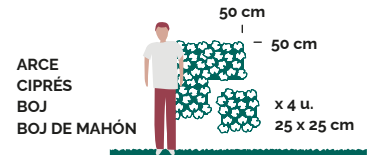

		cm		
43040015	8 422502531370	25x25	8	48



Jardin vertical BUIS
Vertikaler Garten BOXWOOD
Vertical garden BOXWOOD
Ogród wertykalny BOXWOOD

PACK
4u

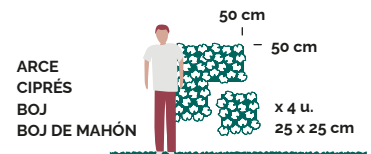

		cm		
43040017	8 422502540754	25x25	8	48



Jardin vertical BUIS LONGIFOLIA
Vertikaler Garten MAHON BOXWOOD
Vertical garden MAHON BOXWOOD
Ogród wertykalny MAHON BOXWOOD

PACK
4u

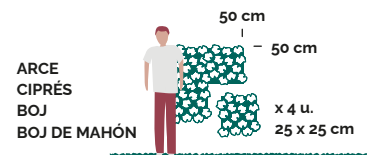

		cm		
43040023	8 422502917426	25x25	8	48



Boules décoratives | Dekorative Kungeln Decorative orbs | Kule ozdobne

FR Les boules décoratives sont un complément indispensable de la décoration de votre maison. En polypropylène, ces boules décoratives garantissent une longue durabilité, en plus d'un réalisme qui surprend au premier regard. Elles peuvent être placées dans n'importe quel coin d'intérieur ou dans le jardin. En outre, elles peuvent être utilisées comme un accessoire de Noël, pour les mariages ou pour tout type d'événement.

DE Ein perfektes Dekorationsobjekt für den Haushalt, das niemanden gleichgültig lässt. Die vertikalen Gartenfliesen können an jeder glatten Wand angebracht werden und bieten einen spektakulären Kontrast, ob zu Hause, im Büro oder in einem anderen Etablissement. Außerdem ist es möglich, die Fliesen oder Rollen aller vertikalen Gartenmodelle einfach mit einem Teppichmesser oder einer Schere zu schneiden.

EN The decorative orbs are an essential complement at home decoration. These are made of polypropylene and guarantee a long durability, as well as a realism that surprises at first sight. It can be placed in any corner inside or in the garden. In addition, it can be used as a Christmas supplement, for weddings or for any type of event.

PL Kule dekoracyjne to obowiązkowy dodatek do domu. Trwałe kule ozdobne wykonane z polipropylenu o naturalnym wyglądzie, które przyciągną spojrzenia. Można nimi udekorować dowolne przestrzenie, wieszając je wewnątrz lub w ogrodzie, a także użyć jako ozdoby na różne uroczystości, wesela i inne imprezy.



Boj Otoñal

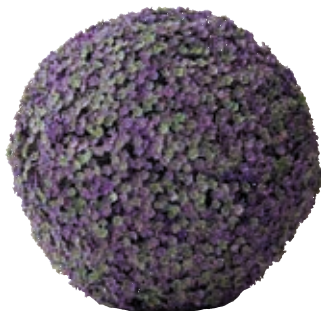

Vinca



Ciprés común



Boj Balear



Jazmín



Boj Común

📦	📏	Product	cm ø	📦	📦
72050001	8 422502 03039 2	BOJ OTOÑAL	18	6	138
72050002	8 422502 72166 5	BOJ OTOÑAL	28	4	40
72050003	8 422502 93345 7	BOJ OTOÑAL	38	1	12
72050007	8 422502 42012 4	VINCA	18	6	138
72050008	8 422502 64097 3	VINCA	28	4	40
72050009	8 422502 40019 5	VINCA	38	1	12
72050013	8 422502 32573 3	CIPRÉS COM.	18	6	138
72050014	8 422502 67042 0	CIPRÉS COM.	28	4	40
72050015	8 422502 57877 1	CIPRÉS COM.	38	1	12
72050016	8 422502 65145 0	BOJ BALEAR	18	6	138
72050017	8 422502 10701 8	BOJ BALEAR	28	4	40
72050018	8 422502 75602 5	BOJ BALEAR	38	1	12
72050028	8 422502 75422 9	JAZMÍN	23	6	138
72050029	8 422502 00454 6	JAZMÍN	33	4	40
72050030	8 422502 17650 2	JAZMÍN	38	1	12
72050022	8 422502 89340 9	BOJ COMÚN	18	6	138
72050023	8 422502 59466 5	BOJ COMÚN	28	4	40
72050024	8 422502 55555 0	BOJ COMÚN	38	1	12



Tuteurs décoratifs | Dekorative stangen Decorative stakes | Kije dekoracyjne

FR Le bambou est un classique de la décoration qui sera qui peut être utilisé à l'intérieur comme à l'extérieur, pour apporter une touche exotique. Nous offrons une gamme de tuteurs décoratifs allant de 35 mm à 90 mm de diamètre et de 180 cm à 240 cm de hauteur. De plus, vous pouvez combiner différentes hauteurs ou sections de canne pour créer une plus grande richesse en décoration.

DE Der Bambus ist ein Klassiker in der Dekoration, der immer sowohl innen als auch außen genutzt werden kann, wodurch jeder Ecke ein exotisches Gefühl verliehen wird. Wir bieten eine Reihe dekorativer Nachhilfelehrer an, die von 35 bis 90 mm Durchmesser reichen und von 180 bis 240 cm Höhe reichen. Darüber hinaus lassen sich verschiedene Zuckerrohrfarben kombinieren, um einen größeren Reichtum an Dekoration zu schaffen.

EN Bamboo is a classic element in decoration that will always be able to be used both inside and outside, giving an exotic touch to any corner. We offer a range of decorative tutors ranging from 35 to 90 mm in diameter and from 180 to 240 cm in height. In addition, different shades of cane can be combined to create a richer decoration.

PL Bambus to klasyk, jeśli chodzi o dekorację wnętrz. Można go umieścić zarówno wewnątrz, jak i na zewnątrz, nadając egzotyczny charakter każdej przestrzeni. Oferujemy szeroką gamę kijów dekoracyjnych o średnicy od 35 do 90 mm i wysokości od 180 do 240 cm. Ponadto można go łączyć z różnymi odcieniami trzciny, aby upiększyć dekorację.



📦	🏠	cm	mm ø	📏	🚚
71030001	8 422502 06102 0	180	35/40	25	1000
71030002	8 422502 06101 3	240	35/40	25	1000
71030003	8 422502 06103 7	180	60/70	4	256
71030004	8 422502 06104 4	240	70/80	4	196
71030005	8 422502 06105 1	240	80/90	4	96



Bambú pelado

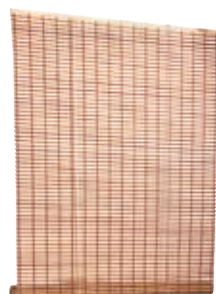

Bombai



Osaka



Kochi



Otawa



Calgary



Niagara



Olive

NEW!



Bambú natural

NEW!



Bambú oscuro

Stores | Jalousien | Blinds | Żaluzje

- FR** Confectionnés à la main avec des bois de première qualité, conçus pour protéger l'intimité de votre foyer.
- DE** Handgefertigt aus erstklassigen Hölzern, für mehr Privatspäre in Ihrem Heim.
- EN** Handmade blinds of high quality wood for more privacy in your home.
- PL** Ręcznie wykonane z najwyższej jakości drewna i zaprojektowane tak, aby zapewnić prywatność w Twoim domu.

🏠	📏	Product	m	📦	🚚
71050001	8422502 11102 2	BAMBÚ PELADO	1x2	10	120
71050002	8422502 11122 0	BAMBÚ PELADO	1,2x2	5	120
71050003	8422502 11152 7	BAMBÚ PELADO	1,5x2	5	120
71050004	8422502 11202 9	BAMBÚ PELADO	2x2	5	120
71050010	8422502 16081 5	BOMBAI	1x2	10	180
71050011	8422502 16082 2	BOMBAI	1,2x2	10	180
71050012	8422502 16083 9	BOMBAI	1,5x2	10	180
71050013	8422502 16107 2	OSAKA	1x2	10	180
71050014	8422502 16109 6	OSAKA	1,2x2	10	180
71050015	8422502 16111 9	OSAKA	1,5x2	10	180
71050016	8422502 16125 6	KOCHI	1x2	10	180
71050017	8422502 16127 0	KOCHI	1,2x2	10	180
71050018	8422502 16129 4	KOCHI	1,5x2	10	180
71050019	8422502 16160 7	OTAWA	1x2	10	180
71050020	8422502 16161 4	OTAWA	1,2x2	10	180
71050021	8422502 16162 1	OTAWA	1,5x2	10	180
71050022	8422502 16166 9	CALGARY	1x2	10	180
71050023	8422502 16167 6	CALGARY	1,2x2	10	180
71050024	8422502 16168 3	CALGARY	1,5x2	10	180
71050025	8422502 16169 0	NIAGARA	1x2	10	180
71050026	8422502 16170 6	NIAGARA	1,2x2	10	180
71050027	8422502 16171 3	NIAGARA	1,5x2	10	180
71050028	8422502 16172 0	OLIVE	1x2	10	180
71050029	8422502 16173 7	OLIVE	1,2x2	10	180
71050030	8422502 16174 4	OLIVE	1,5x2	10	180
71050031	8422502 39849 2	BAMBÚ NATURAL	1x2	10	-
71050032	8422502 83455 6	BAMBÚ NATURAL	1,2x2	5	-
71050033	8422502 78163 8	BAMBÚ NATURAL	1,5x2	5	-
71050034	8422502 86195 8	BAMBÚ NATURAL	2x2	5	-
71050035	8422502 20304 8	BAMBÚ OSCURO	1x2	10	-
71050036	8422502 37640 7	BAMBÚ OSCURO	1,2x2	5	-
71050037	8422502 41951 7	BAMBÚ OSCURO	1,5x2	5	-
71050038	8422502 70486 6	BAMBÚ OSCURO	2x2	5	-

NEW!

NEW!

NEW!

NEW!

NEW!

NEW!

NEW!

NEW!



Formosa

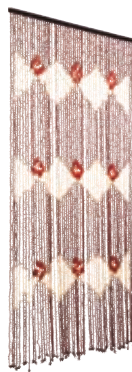

Tonkin



Habanera



Taiping



Hong Kong Marfil



Hong Kong Burdeos



Shanghai Marfil



Rainbow



Planets



Sunset

NEW!



Rio de Janeiro

NEW!



Etna

Rideaux en bois | Holzvorhänge Wood curtains | Drewniane paski na drzwi

- FR** Confectionnés à la main avec des bois de première qualité, conçus pour protéger l'intimité de votre foyer.
- DE** Handgefertigt aus erstklassigen Hölzern, für mehr Privatspäre in Ihrem Heim.
- EN** Handmade blinds of high quality wood for more privacy in your home.
- PL** Dekoracyjne drewniane zastony, wykonane ręcznie z naturalnych włókien. Modele przeznaczone do dekoracji zarówno drzwi wejściowych do domu, jak i drzwi wewnętrznych lub ogrodowych.

		Product	m			
71060002	8 422502 180615	FORMOSA	0,9x2	60	10	80
71060003	8 422502 180684	TONKIN	0,9x2	60	10	80
71060004	8 422502 180691	HABANERA	0,9x2	56	10	80
71060005	8 422502 180707	TAIPING	0,9x2	60	10	80
71060006	8 422502 180813	HONG KONG MARFIL	0,9x2	70	10	80
71060007	8 422502 180837	HONG KONG BURDEOS	0,9x2	70	10	80
71060008	8 422502 180851	SHANGHAI MARFIL	0,9x2	72	10	80
71060019	8 422502 760718	RAINBOW	0,9x2	60	10	120
71060020	8 422502 759217	PLANETS	0,9x2	60	10	120
71060026	8 422502 294077	SUNSET	0,9x2	60	10	120
71060027	8 422502 282685	RIO DE JANEIRO	0,9x2	35	10	120
71060028	8 422502 187386	ETNA	0,9x2	45	10	120

NEW!
NEW!



Fruits | Früchte | Fruits | Owoce

- FR** La section de fruits et légumes décoratifs est née avec le désir d'apporter de la couleur et de la fraîcheur dans vos maisons, bureaux, magasins, événements... Notre large choix d'imitations de fruits et légumes vous permet de réaliser des compositions suivant vos inspirations.
- DE** Dekoratives Obst und Gemüse wird mit dem Wunsch geboren, jedem Ort Farbe und Frische zu verleihen: Häuser, Büros, Geschäfte, Veranstaltungen... Wir haben unzählige Obst- und Gemüsestücke zur Auswahl.
- EN** Decorative fruits and vegetables born with the desire to give color and freshness to any place: homes, offices, shops, events... We have plenty of pieces of fruit and vegetables to choose from.
- PL** Dekoracyjne owoce i warzywa służą aby nadać świeżości i ożywić każde wnętrze: domowe, biurowe, sklepowe... Ogromna liczba owoców i warzyw od wyboru. Są to bardzo trwałe dekoracje wielokrotnego użytku, które można łączyć na tysiące sposobów w dowolnym momencie.



Fruit décoratif
Dekofrüchte
Decorative fruits
 Służą wyłącznie do dekoracji

info

		Product	cm		
72020029	8 422502 24773 8	CARAMBOLA	10x6,5	10	1440
72020007	8 422502 92425 7	CIRUELA GRANDE	7,5x8	10	1200
72020006	8 422502 97896 0	CIRUELA NEGRA	5,5x6	10	3040
72020002	8 422502 88848 1	CIRUELA ROJA	5x6	10	2560
72020019	8 422502 96049 1	GRANADA	10x9	10	840
72020047	8 422502 24119 4	KIWI	7,5	10	2890
72020053	8 422502 85284 0	LIMA	6,5x5	10	5760
72020023	8 422502 18983 0	LIMÓN LISO	9x7	10	2040
72020032	8 422502 45346 7	LIMÓN RUGOSO	9x6	10	2550
72020028	8 422502 54007 5	MANDARINA LISA	6,5x8	10	980
72020030	8 422502 41094 1	MANDARINA RUGOSA	6x7	10	2550
72020015	8 422502 86006 7	MANGO	15x8	10	780
72020005	8 422502 76587 4	MANZANA GOLDEN	8x8	10	1220
72020046	8 422502 45608 6	MELOCOTÓN	7,5x7,5	12	1716
72020056	8 422502 98902 7	MELÓN AMBROSIA	13x7,5	6	240
72020020	8 422502 18717 1	PERA GRANDE	10,5x10	10	700
72020025	8 422502 23341 0	PERA MEDIANA	8,5x10	10	1170
72020026	8 422502 27762 9	PLÁTANO	18x5	10	1600
72020058	8 422502 25545 0	SANDÍA	21x26	6	48



72020029
Carambola



72020007
Ciruela grande



72020006
Ciruela negra



72020002
Ciruela roja



72020019
Granada



72020047
Kiwi



72020053
Lima



72020023
Limón liso



72020032
Limón rugoso



72020028
Mandarina lisa



72020030
Mandarina rugosa



72020015
Mango



72020005
Manzana Golden



72020046
Melocotón



72020056
Melón Ambrosia



72020025
Pera mediana



72020020
Pera grande



72020026
Plátano



72020058
Sandía



Légumes | Gemüse | Vegetables | Warzywa

FR La section de fruits et légumes décoratifs est née avec le désir d'apporter de la couleur et de la fraîcheur dans vos maisons, bureaux, magasins, événements... Notre large choix d'imitations de fruits et légumes vous permet de réaliser des compositions suivant vos inspirations.

DE Dekoratives Obst und Gemüse wird mit dem Wunsch geboren, jedem Ort Farbe und Frische zu verleihen: Häuser, Büros, Geschäfte, Veranstaltungen... Wir haben unzählige Obst- und Gemüsestücke zur Auswahl.

EN Decorative fruits and vegetables born with the desire to give color and freshness to any place: homes, offices, shops, events... We have plenty of pieces of fruit and vegetables to choose from.

PL Dekoracyjne owoce i warzywa służą aby nadać świeżości i ożywić każde wnętrze: domowe, biurowe, sklepowe... Ogromna liczba owoców i warzyw od wyboru. Są to bardzo trwałe dekoracje wielokrotnego użytku, które można łączyć na tysiące sposobów w dowolnym momencie.

Légumes décoratifs
Dekogemüse
Decorative vegetables
Warzywa ozdobne

info



72020042
Ajos tiernos



72020036
Apio



72020018
Berenjena



72020013
Calabaza



72020055
Calabaza americana G.



72020054
Calabaza americana P.



72020014
Cebolla

🏠		Product	cm	📦	🚚
72020042	8 422502 61985 6	AJOS TIERNOS	30x3,5	12	2880
72020036	8 422502 52672 7	APIO	12x39	6	816
72020018	8 422502 74504 3	BERENJENA	17x6	10	1260
72020013	8 422502 96937 1	CALABAZA	10x5	10	1560
72020055	8 422502 12627 9	CALABAZA AMER. G.	26x13	6	96
72020054	8 422502 86305 1	CALABAZA AMER. P.	18x13	6	144
72020014	8 422502 53813 3	CEBOLLA	6x7	10	1680
72020010	8 422502 86670 0	COL MORADA	9x12	10	660
72020011	8 422502 89682 0	COL VERDE	9x12	10	660
72020050	8 422502 22216 2	COLIFLOR	14x10	12	960
72020045	8 422502 85675 6	JUDÍAS	17x3,5	10	4250
72020008	8 422502 68511 0	LECHUGA	14x16	10	660
72020049	8 422502 80276 0	LECHUGA II	12x10	10	1300
72020051	8 422502 10273 0	LECHUGA MORADA	19x16	6	480
72020057	8 422502 53441 8	LECHUGA ROMANA	11x9x12	8	640
72020012	8 422502 91839 3	LOMBARDA	12x12	10	480
72020009	8 422502 90841 7	NABO	40x6	10	560
72020016	8 422502 21756 4	NÍSCALO	10x10	10	1320
72020048	8 422502 47289 5	PATATA	12x7	12	1260
72020027	8 422502 15764 8	PEPINO	21x5	10	640
72020039	8 422502 12316 2	PIMIENTO DULCE AMAR.	10x8	10	1800
72020038	8 422502 88224 3	PIMIENTO DULCE ROJO	10x8	10	1800
72020037	8 422502 82043 6	PIMIENTO DULCE VERDE	10x8	10	1800
72020041	8 422502 30677 0	PIMIENTO ROJO	14x4,5	10	3360
72020040	8 422502 06938 5	PIMIENTO VERDE	14x4,5	10	3360
72020017	8 422502 33793 4	SETA	7x7	24	2880
72020044	8 422502 80278 4	TOMATE RAMA CLARO	20x9x4	12	1728
72020052	8 422502 74650 7	TOMATE RAMA MADURO	20x9x4	12	1440
72020024	8 422502 61446 2	TOMATE VERDE	6x7	10	1950
72020043	8 422502 92569 8	TOMATE RAF	6x7	10	3200
72020021	8 422502 11000 1	TOMATE ROJO	6x6x6	12	1836
72020066	8 422502 74466 4	ZANAHORIA	30x4x3,5	96	-
72020067	8 422502 83297 2	COLIFLOR II	13x15	12	-
72020068	8 422502 70070 7	LECHUGA ROBLE	7x4,6x5,2	12	96
72020069	8 422502 55503 1	LECHUGA R. MORADA	7x4,6x5,2	12	96
72020070	8 422502 42309 5	LECHUGA ICEBERG	6,5x4,6x6	6	60
72020071	8 422502 46963 5	LECHUGA I. MORADA	5,7x4,6x6	12	60



72020010
Col morada



72020011
Col verde



72020050
Coliflor



72020045
Judías



72020008
Lechuga



72020049
Lechuga II



72020051
Lechuga morada



72020057
Lechuga romana



72020012
Lombarda



72020009
Nabo



72020016
Niscallo



72020048
Patata



72020027
Pepino



72020039
Pimiento dulce amarillo



72020038
Pimiento dulce rojo



72020037
Pimiento dulce verde



72020041
Pimiento rojo



72020040
Pimiento verde



72020017
Seta



72020044
Tomate rama claro



72020052
Tomate rama maduro



72020024
Tomate verde



72020043
Tomate Raf



72020021
Tomate rojo



72020066
Zanahoria



72020067
Coliflor II

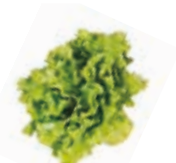

72020068
Lechuga Roble



72020069
Lechuga Roble morada



72020070
Lechuga Iceberg



72020071
Lechuga Iceberg morada



Présentoirs | Displays | Displays
Zestawy wystawowe

- FR** Avec Catral vous pouvez compter sur notre aide pour aménager votre linéaire avec des présentoirs, box ou ILV.
- DE** In Catral Garden können Sie personalisierte Flächen für Ihr Geschäft haben. Für weitere Informationen wenden Sie sich bitte an Ihren Verkaufsberater.
- EN** Catral Garden helps you to create pop-ups for your shop. Consult your sales agent for more information.
- PL** W Catral Garden będziesz mógł mieć spersonalizowaną przestrzeń dla swojego sklepu. Aby uzyskać więcej informacji, należy skontaktować się z przedstawicielem handlowym.

	🏠		Product
1	71090029	8 422502 27595 3	EXPOSITOR CELOSIAS (BASE ANCHA) *
2	81020011	8 422502 80841 0	EXPOSITOR UNIVERSAL *
	40010007	8 422502 49174 2	BALDOSA MADERA LOP®
3	40010010	8 422502 41075 0	BALDOSA PIEDRA LOP®
	40010011	8 422502 07831 8	BALDOSA PIZARRA LOP®
	49020004	8 422502 43733 7	BOX B. TRONCO BLANCO LOP®
	49020005	8 422502 48792 9	BOX B. TRONCO MARRÓN LOP®
	49020006	8 422502 91258 2	BOX B. TRONCO VERDE LOP®
	49020007	8 422502 81156 4	BOX B. TRONCO COMBINADO LOP®
4	49020008	8 422502 45027 5	BOX B. TRONCO COMB. MARRÓN-VERDE
	49010010	8 422502 67979 9	BOX B. TABLA BLANCO LOP®
	49010011	8 422502 75154 9	BOX B. TABLA MARRÓN LOP®
	49010012	8 422502 27555 7	BOX B. TABLA VERDE LOP®
	49010013	8 422502 26624 1	BOX B. TABLA COMBINADO LOP®
	49010015	8 422502 43282 0	BOX B. TABLA COMB. MARRÓN-VERDE
5.1	71090043	-	EXPOSITOR CESPED 107X90 CM
5.2	71090042	-	EXPOSITOR CESPED 160X107 CM
6	72020035	8 422502 03585 4	EXPOSITOR FRUTAS Y VERDURAS
7	81020194	8 422502 63846 8	CESTO METÁLICO MALLAS

Éléments non inclus dans le présentoir | Items not included in exhibitors | Displayzubehör Nicht Inklusive
 Elementy nieuwzględnione w zestawach wystawowych

	🏠	Product
	81020012	ETAGÈRE
	81020013	SÉPARATEURS
	81020014	PORTE-PRIX



ILV | Auswahl | Pedagogies | Materiały dydaktyczne

- FR** ILV mettant en avant les spécificités du produit et ses avantages pour le client.
- DE** Didaktisches Material, um dem Kunden die notwendigen Informationen zur Kenntnis des Produkts zu vermitteln.
- EN** POS information to provide the customer useful information about the product.
- PL** Materiał dydaktyczny zapewniający wszelkie niezbędne informacje o produktach.

	🏠	Product
	81020173	PEDAGOGIAS TIENDA PROTECCION
	81020174	PEDAGOGIAS TIENDA LOP
	81020175	PEDAGOGIAS TIENDA NATURAL
	81020176	PEDAGOGIAS TIENDA PVC
	81020177	PEDAGOGIAS TIENDA SETO
	81020178	PEDAGOGIAS TIENDA MALLAS
	81020179	PEDAGOGIAS TIENDA CRECIMIENTO
	81020180	PEDAGOGIAS TIENDA RECOGIDA
	81020181	PEDAGOGIAS TIENDA ACCESORIOS

SOLUTIONS AU POINT DE VENTE | LÖSUNGEN FÜR DIE VERKAUFSSTELLE
 POINT-OF-SALE SOLUTIONS | ROZWIĄZANIA W MIEJSCU SPRZEDAŻY

Ícônes explicatives | Piktogrammübersicht | Information icons | objaśnienie symboli

	Produit écologique Organisches Produkt Organic product Produkt ekologiczny		Guides de sols inclus Mit Hilfe von Bodenführung Floor guides included W zestawie prowadnice podłogowe		Fabriqué à Catral Hergestellt in Catral Made in Catral Wyprodukowano w zakładzie Catral
	Niveau d'occultation Sichtschutz Level Screening level Poziom maskowania		Acier galvanisé Verzinkter Stahl Galvanized steel Stal galwanizowana		Ignifuge Schwer entflammbar Non-flammable Ogniodporny
	Résistant au soleil Sonnenresistent Sun-resistant Odporność na słońce		Prix spécial Sonderpreis Special price Cena specjalna		Sans métaux lourds Keine Schwermetalle No heavy metals Bez metali ciężkich
	Résistant à l'eau Wasserabweisend Water-resistant Wodoodporność		Fabriqué en Espagne Hergestellt in Spanien Made in Spain Wyprodukowano w Hiszpanii		Protection UV UV-Schutz UV resistant Ochrona przed promieniowaniem UV
	Produit recyclé Recyceltes Produkt Recycled product Produkt z recyklingu		Fabriqué à Catral Hergestellt in Catral Made in Catral Wyprodukowano w zakładzie Catral		Feuilles très résistantes Sehr widerstandsfähige Blätter Very resistant leaves Wysoka wytrzymałość
	Facile à couper Einfaches Schneiden Easy cutting Łatwy doęcia		Exclusif Catral Catral exklusiv Exclusive Catral Produkt marki Catral		Système de drainage Drainage system Drainage system System drenazowy
	Ignifuge Schwer entflammbar Non-flammable Ogniodporny		Haute qualité Hohe Qualität High quality Wysoka jakość		Prix spécial Sonderpreis Special price Cena specjalna
	Sans métaux lourds Keine Schwermetalle No heavy metals Bez metali ciężkich		Occultation moyenne Mittlerer Sichtschutz Medium privacy Średni poziom maskowania		Produit recyclé et recyclable Recyceltes und recycelbares Produkt Recycled and recyclable product Produkt z recyklingu i nadający się do powtórnego przetworzenia
	Respirable Atmungsaktiv Breathable Przewiewny		Haute occultation Hoher Sichtschutz High privacy Wysoki poziom maskowania		Approprié pour les animaux Haustier freundlich Pet friendly Przyjazny zwierzętom
	Montage facile Einfacher Aufbau Easy assembly Łatwy w montażu		Produit écologique Organisches Produkt Organic product Produkt ekologiczny		Doux au toucher Sanfter Taktgefühl Soft feel Miękkość
	Augmente la température Zur Temperaturerhöhung Increases temperature Odporny na zmiany temperatury		Résistant à l'eau Wasserabweisend Water resistant Wodoodporność		Aspect réel Reales aussehen Real appearance Naturalny wygląd
	Protège des mauvaises herbes Schützt vor dem Unkraut Protection from weeds Ochrona przed chwastami		Résistant au vent Windabweisend Wind resistant Odporność na wiatr		Haute résistance Alta resistencia High resistance Duża odporność
	Accessoires de fixation inclus Befestigungszubehör enthalten Fixing accessories included W zestawie akcesoria do mocowania		Installation facile Einfache Installation Easy to install Łatwy montaż		Récupération facile Leichte Wiederherstellung Easy recovery Odporność na deptanie
	Anti-oiseaux Schutz vor Vögeln Bird protection Ochrona przed ptakami		Niveau d'occultation Sichtschutz Level Screening level Maskowanie		Fabrication durable Nachhaltige Produktion Sustainable manufacturing Zrównoważona produkcja
	Garantie Garantie Warranty Gwarancja		Fabriqué en Espagne Hergestellt in Spanien Made in Spain Wyprodukowano w Hiszpanii		
	Grammage Grammatur Grammage Gramatura				



Catalogue Katalog 2022

catralgarden.com



CATRAL GARDEN AND HOME DEPOT, S.A.

CATRAL ESPAÑA | Ctra. Catral - San Isidro, km. 1, 03158 Catral, Alicante, España | T. (+34) 965 723 194 | F. (+34) 965 723 593 | info@catralgarden.com

CATRAL FRANCE | 377 Rue Jules Guesde | 59650. Villeneuve d'Ascq | T. +33 (0) 986 65 02 15 | contact@catralgarden.fr